



CI-V REFERENCE GUIDE

HF/VHF/UHF ALL MODE
TRANSCEIVER

IC-705

TABLE OF CONTENTS

REMOTE CONTROL	2	
Remote control (CI-V) information	2	
◇ CI-V connection.....	2	
◇ Preparing.....	2	
◇ About the data format.....	2	
◇ Command table.....	3	
◇ Command formats.....	17	
• Operating frequency	17	
• Operating mode.....	17	
• Band edge frequency settings	17	
• Duplex Offset frequency setting.....	17	
• Codes for CW message contents	17	
• Memory content.....	18	
• Codes for character entries	19	
• Band stacking register	19	
• Keyer memory character entries	20	
• Keyer memory content	20	
• IF filter width settings.....	20	
• AGC time constant settings	20	
• RX HPF/LPF setting for each operating mode...	20	
• SSB/SSB-DATA transmission passband width settings	20	
• Split offset frequency setting.....	20	
• UTC Offset setting	21	
• Remote MIC Key setting.....	21	
• Color settings.....	21	
• Bandscope edge frequency settings	21	
• [VOX/BK-IN] setting.....	21	
• [AUTOTUNE/RX>CS] setting	22	
• Manually entered position data.....	22	
• D-PRS Symbol setting.....	22	
• Alarm area (Group) setting	22	
• Data mode with filter width settings	22	
• Repeater tone/tone squelch frequency settings	22	
• DTCS code and polarity setting.....	22	
• DV Digital code squelch setting.....	23	
• DV MY call sign setting.....	23	
• DV TX call signs setting (24 characters)....	23	
• DV TX message setting	23	
• DV RX call sign data.....	23	
• DV RX message	24	
• DV RX Status setting.....	24	
• GPS/D-PRS data	24	
• GPS/D-PRS message	26	
• RIT frequency settings.....	26	
• DV TX data	26	
• DV RX data (transceive).....	26	
• MY position data.....	26	
• Selected or unselected VFO frequency settings	27	
• Selected or unselected VFO's operating mode and filter settings	27	
• Scope waveform data.....	27	
• Scope span settings (in the Center mode and SCROLL-C mode Scope).....	28	
• Scope Reference level settings	28	
• Scope Fixed edge frequency settings	28	

REMOTE CONTROL

Remote control (CI-V) information

◇ CI-V connection

The transceiver's operating frequency, mode, VFO and memory selection, can be remotely controlled using a PC.

The Icom Communications Interface V (CI-V) controls the transceiver.

Connect the transceiver to a PC with a USB cable (User supplied).

- ① Make the connection as short as possible. The transceiver may not be recognized by the controller, depending on the USB cable length.
- ② When connecting to a USB port on your PC with the USB driver installed, USB (A) and USB (B) are named as "IC-705 Serial Port A (CI-V)" and "IC-705 Serial Port B."

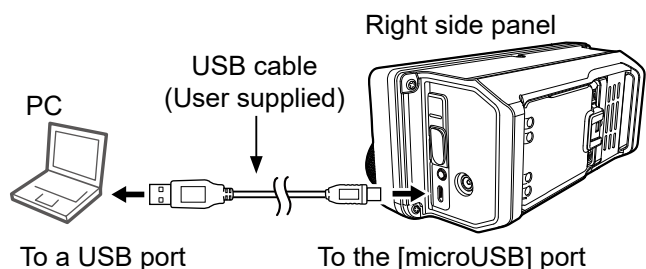

To use the USB cable between the transceiver and a PC, you must first install a USB driver. The latest USB driver and installation guide can be downloaded from the Icom website. Carefully read the guide, before installing the driver. <https://www.icomjapan.com/support/>

◇ Preparing

The Icom Communications Interface V (CI-V) is used for remote control.

To control the transceiver, first set its address, data communication speed, and transceive function.

These settings are set in the Set mode (Refer to the IC-705 instruction manual).

◇ About the data format

The CI-V system can be written using the following data formats. Data formats differ according to command numbers. A data area or sub command is added for some commands.

Controller to IC-705

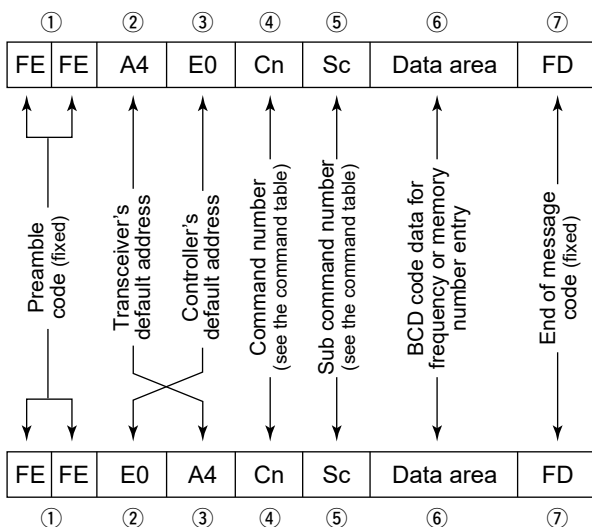

IC-705 to controller

OK message to controller

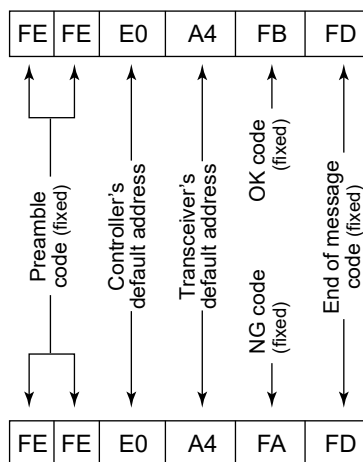

NG message to controller

REMOTE CONTROL

Remote control (CI-V) information

◇ Command table

Cmd.	Sub cmd.	Data	Description
00		See p. 17.	Send the frequency data (transceive)
01		See p. 17.	Send the mode data (transceive)
02* ¹		See p. 17.	Read the band edge frequencies
03* ¹		See p. 17.	Read the operating frequency
04* ¹		See p. 17.	Read the operating mode
05* ²		See p. 17.	Set the operating frequency
06* ²		See p. 17.	Set the operating mode
07			Select the VFO mode
	00		Select VFO A
	01		Select VFO B
	A0		Equalize VFO A and VFO B ① When the split frequency operation is OFF in the Memory mode or the Call channel mode, "FA" (NG) is returned.
	B0		Exchange VFO A and VFO B. ① When the split frequency operation is OFF in the Memory mode or the Call channel mode, "FA" (NG) is returned.
08* ²			Select the Memory mode
		0000 ~ 0099	Select the Memory channel (Memory channel: 0000 ~ 0099 Call channel: 0000 (144C1), 0001 (144C2), 0002 (430C1), 0003 (430C2))
	A0	0000 ~ 0100	Select the Memory group (Memory channel group: 0000 ~ 0099 Call channel group: 0100)
09			Memory write
0A			Memory copy to VFO
0B			Memory clear
0C* ¹		See p. 17.	Read frequency offset
0D* ²		See p. 17.	Send frequency offset
0E	00		Cancel the scan
	01		Start a Programmed/memory scan
	02		Start a Programmed scan
	03		Start a ΔF scan
	12		Start a Fine programmed scan
	13		Start a Fine ΔF scan
	22		Start a Memory scan
	23		Start a Select memory scan
	24		Start a Mode Select scan
	Ax* ² (x=1 ~ 7)		Select ΔF scan span (x=1 (±5kHz), x=2 (±10kHz), x=3 (±20kHz), x=4 (±50kHz), x=5 (±100kHz), x=6 (±500kHz), x=7 (±1MHz))
	B0* ²		Clear the Select channel setting

Cmd.	Sub cmd.	Data	Description
0E	B1* ²		Set as select channel ① The previously set number by CI-V is set after turning power ON, or "1" is selected if no selection is performed.
		01 ~ 03	Set the channel as a Select channel (01=SEL1, 02=SEL2, 03=SEL3)
	B2* ²	00 ~ 03	Set the Select memory scan channel (00=ALL, 01=SEL1, 02=SEL2, 03=SEL3)
	D0* ²		Set Scan resume OFF
	D3* ²		Set Scan resume ON (Close&Delay)
0F		00* ¹	Read Split OFF setting
		01* ¹	Read Split ON setting
		11* ¹	Read DUP- operation
		12* ¹	Read DUP+ operation
		00* ²	Set Split function OFF
		01* ²	Set Split function ON
		10* ²	Set the simplex operation
		11* ²	Set DUP- operation
		12* ²	Set DUP+ operation
10*		00 ~ 13	Send/read the tuning step (00=OFF (10Hz or 1Hz) 01=100Hz 02=500Hz 03=1kHz 04=5kHz 05=6.25kHz 06=8.33kHz 07=9kHz 08=10kHz 09=12.5kHz 10=20kHz 11=25kHz 12=50kHz 13=100kHz)
11*		00	Send/read attenuator OFF setting
		20	Send/read 20 dB attenuator setting ① You can set in the HF and 50 MHz bands.
13	00		Speech all data by voice synthesizer (S meter level, frequency, and mode)
	01		Speech the operating frequency and S meter level by voice synthesizer
	02		Speech the operating mode by voice synthesizer ① The mode is announced after the ongoing speech.
14*	01	0000 ~ 0255	Send/read the AF level (0000=Minimum ~ 0255=Maximum)
	02	0000 ~ 0255	Send/read the RF gain level (0000=Minimum ~ 0255=Maximum)
	03	0000 ~ 0255	Send/read the squelch level (0000=Minimum ~ 0255=Maximum)
	06	0000 ~ 0255	Send/read the NR level (0000=0% ~ 0255=100%)
	07	0000 ~ 0255	Send/read [TWIN PBT] (PBT1) position (0000=max. Counter Clockwise ~ 0128=center ~ 0255=max. Clockwise)
	08	0000 ~ 0255	Send/read [TWIN PBT] (PBT2) position (0000=max. Counter Clockwise ~ 0128=center ~ 0255=max. Clockwise)

REMOTE CONTROL

Remote control (CI-V) information

◇ Command table

Cmd.	Sub cmd.	Data	Description
14*	09	0000 ~ 0255	Send/read CW pitch (5 Hz steps) (0000=300 Hz ~ 0128=600 Hz ~ 0255=900 Hz)
	0A	0000 ~ 0255	Send/read the selected band's RF power (0000=Minimum ~ 0255=Maximum)
	0B	0000 ~ 0255	Send/read MIC gain (0000=Minimum ~ 0255=Maximum)
	0C	0000 ~ 0255	Send/read keying speed (0000=6 WPM ~ 0255=48 WPM)
	0D	0000 ~ 0255	Send/read Notch filter setting (0000=max. Counter Clockwise ~ 0128=center ~ 0255=max. Clockwise)
	0E	0000 ~ 0255	Send/read the COMP level (0000=0 ~ 0255=10)
	0F	0000 ~ 0255	Send/read the Break-IN Delay setting (0000=2.0d ~ 0255=13.0d)
	12	0000 ~ 0255	Send/read NB level (0000=0% ~ 0255=100%)
	15	0000 ~ 0255	Send/read Monitor audio [MONI] level (0000=0% ~ 0255=100%)
	16	0000 ~ 0255	Send/read the VOX gain (0000=0% ~ 0255=100%)
	17	0000 ~ 0255	Send/read the Anti VOX gain (0000=0% ~ 0255=100%)
	19	0000 ~ 0255	Send/read LCD backlight brightness (0000=0% ~ 0255=100%)
	15*1	01	00/01
02		0000 ~ 0255	Read S-meter level (0000=S0, 0120=S9, 0241=S9+60 dB)
05		00/01	Read various squelch (tone squelch, and so on) status (00=Close, 01=Open)
07		00/01	Read the OVF status (00=OVF indicator is OFF, 01=OVF indicator is ON)
11		0000 ~ 0255	Read the Po meter level (0000=0% ~ 0143=50% ~ 0213=100%)
12		0000 ~ 0255	Read SWR meter level (0000=SWR1.0, 0048=SWR1.5, 0080=SWR2.0, 0120=SWR3.0)
13		0000 ~ 0255	Read ALC meter level (0000=Minimum ~ 0120=Maximum)
14		0000 ~ 0255	Read COMP meter level (0000=0 dB ~ 0130=15 dB ~ 0210=25.5 dB)
15	0000 ~ 0255	Read Vd meter level (0000=0 V ~ 0075=5 V ~ 0241=16 V)	
16	0000 ~ 0255	Read Id meter level (0000=0 A ~ 0121=2 A ~ 0241=4 A)	
16*	02	00 ~ 02	Send/read the Preamp (00=OFF, 01=P.AMP1, 02=P.AMP2) (In the 144 or 430 MHz bands, 00=OFF, 01=ON)
	12	01 ~ 03	Send/read the AGC time constant (01=FAST, 02=MID, 03=SLOW)

Cmd.	Sub cmd.	Data	Description
16*	22	00/01	Send/read the Noise blanker (00=OFF, 01=ON)
	40	00/01	Send/read the Noise reduction (00=OFF, 01=ON)
	41	00/01	Send/read the Auto Notch function (00=OFF, 01=ON)
	42	00/01	Send/read the Repeater tone (00=OFF, 01=ON)
	43	00/01	Send/read the Tone squelch (00=OFF, 01=ON)
	44	00/01	Send/read the Speech compressor (00=OFF, 01=ON)
	45	00/01	Send/read the Monitor [MONI] function (00=OFF, 01=ON)
	46	00/01	Send/read the VOX function (00=OFF, 01=ON)
	47	00 ~ 02	Send/read the BK-IN function (00=BK-IN OFF, 01=Semi BK-IN ON, 02=Full BK-IN ON)
	48	00/01	Send/read the Manual Notch function (00=OFF, 01=ON)
	4B	00/01	Send/read the DTCS function (00=OFF, 01=ON)
	4F	00/01	Send/read the Twin peak filter (00=OFF, 01=ON) (Can be turned ON only when Mark and Shift are set to 2125 Hz and 170 Hz, respectively)
	50	00/01	Send/read the Dial lock function (00=OFF, 01=ON)
	56	00/01	Send/read DSP IF filter type in the operating band (00=SHARP, 01=SOFT)
	57	00 ~ 02	Send/read the Manual Notch width (00=WIDE, 01=MID, 02=NAR)
	58	00 ~ 02	Send/read SSB transmit bandwidth (00=WIDE, 01=MID, 02=NAR) (One of following values is applied, depending on the "COMP" status (ON or OFF): WIDE (Command: 1A 05 0017), MID (Command: 1A 05 0018), or NAR (Command: 1A 05 0019))
	5B	00 ~ 02	Send/read the DSQ (Digital Call Sign squelch)/CSQ (Digital Code squelch) setting (DV mode only) (00=OFF, 01=DSQ, 02=CSQ)
	5C	00 ~ 02	Send/read the GPS TX mode (00=OFF, 01=D-PRS, 02=NMEA)
	5D	00 ~ 03, 06 ~ 09	Send/read the Tone squelch function (00=OFF, 01=TONE, 02=TSQ, 03=DTCS, 06=DTCS (T), 07=TONE (T)/DTCS (R), 08=DTCS (T)/TSQ (R), 09=TONE (T)/TSQ (R))
	17*3		See p. 17.
18	00		Turn OFF the transceiver
	01*4		Turn ON the transceiver

REMOTE CONTROL

Remote control (CI-V) information

◇ Command table

Cmd.	Sub cmd.	Data	Description
19*1	00		Read the transceiver ID
1A*	00	See pp. 18 and 19.	Send/read memory contents
	01	See p. 19.	Send/read band stacking register contents
	02*5	See p. 20.	Send/read memory keyer contents
	03	See p. 20.	Send/read the selected IF filter width
	04	See p. 20.	Send/read the selected AGC time constant
	05	SET > Tone Control/TBW	
	0001	See p. 20.	RX > SSB > Send/read RX HPF/LPF settings
	0002	00 ~ 10	RX > SSB > Send/read RX Tone (Bass) level (00=-5 ~ 10=+5)
	0003	00 ~ 10	RX > SSB > Send/read RX Tone (Treble) level (00=-5 ~ 10=+5)
	0004	See p. 20.	RX > AM > Send/read RX HPF/LPF settings
	0005	00 ~ 10	RX > AM > Send/read RX Tone (Bass) level (00=-5 ~ 10=+5)
	0006	00 ~ 10	RX > AM > Send/read RX Tone (Treble) level (00=-5 ~ 10=+5)
	0007	See p. 20.	RX > FM > Send/read RX HPF/LPF settings
	0008	00 ~ 10	RX > FM > Send/read RX Tone (Bass) level (00=-5 ~ 10=+5)
	0009	00 ~ 10	RX > FM > Send/read RX Tone (Treble) level (00=-5 ~ 10=+5)
	0010	See p. 20.	RX > DV > Send/read RX HPF/LPF settings
	0011	00 ~ 10	RX > DV > Send/read RX Tone (Bass) level (00=-5 ~ 10=+5)
	0012	00 ~ 10	RX > DV > Send/read RX Tone (Treble) level (00=-5 ~ 10=+5)
	0013	00 ~ 10	RX > WFM > Send/read RX Tone (Bass) level (00=-5 ~ 10=+5)
	0014	00 ~ 10	RX > WFM > Send/read RX Tone (Treble) level (00=-5 ~ 10=+5)
0015	See p. 20.	RX > CW > Send/read RX HPF/LPF settings	
0016	See p. 20.	RX > RTTY > Send/read RX HPF/LPF settings	
0017	00 ~ 10	TX > SSB > Send/read TX Tone (Bass) level (00=-5 ~ 10=+5)	
0018	00 ~ 10	TX > SSB > Send/read TX Tone (Treble) level (00=-5 ~ 10=+5)	
0019	See p. 20.	TX > SSB > Send/read TX bandwidth for wide	

Cmd.	Sub cmd.	Data	Description	
1A*	05	SET > Tone Control/TBW		
	0020	See p. 20.	TX > SSB > Send/read TX bandwidth for mid	
	0021	See p. 20.	TX > SSB > Send/read TX bandwidth for narrow	
	0022	See p. 20.	TX > SSB-D > Send/read TX bandwidth	
	0023	00 ~ 10	TX > AM > Send/read TX Tone (Bass) level (00=-5 ~ 10=+5)	
	0024	00 ~ 10	TX > AM > Send/read TX Tone (Treble) level (00=-5 ~ 10=+5)	
	0025	00 ~ 10	TX > FM > Send/read TX Tone (Bass) level (00=-5 ~ 10=+5)	
	0026	00 ~ 10	TX > FM > Send/read TX Tone (Treble) level (00=-5 ~ 10=+5)	
	0027	00 ~ 10	TX > DV > Send/read TX Tone (Bass) level (00=-5 ~ 10=+5)	
	0028	00 ~ 10	TX > DV > Send/read TX Tone (Treble) level (00=-5 ~ 10=+5)	
	SET > Function			
	0029	0000 ~ 0255	Send/read the Beep Level setting (0000=Minimum ~ 0255=Maximum)	
	0030	00/01	Send/read the Beep Level Limit setting (00=OFF, 01=ON)	
	0031	00/01	Send/read the Beep (Confirmation) setting (00=OFF, 01=ON)	
	0032	00/01	Send/read the Home CH Beep setting (00=OFF, 01=ON)	
	0033	00 ~ 03	Send/read the Band Edge Beep setting (00=OFF, 01=ON (Default), 02=ON (User), 03=ON (User) & TX Limit)	
	0034	00 ~ 04	Send/read the Auto Power OFF setting (00=OFF, 01=30 min, 02=60 min, 03=90 min, 04=120 min)	
	0035	00 ~ 03	Send/read the Power Save setting (00=OFF, 01=Auto (Short), 02=Auto (Middle), 03=Auto (Long))	
	0036	00 ~ 03	Send/read the Max TX Power (Battery Pack) setting (00=0.5 W, 01=1 W, 02=2.5 W, 03=5 W)	
	0037	00 ~ 04	Send/read the Max TX Power (DC 13.8V) setting (00=0.5 W, 01=1 W, 02=2.5 W, 03=5 W, 04=10 W)	
0038	00 ~ 05	Send/read the TX Delay (HF) setting (00=OFF, 01=10 ms, 02=15 ms, 03=20 ms, 04=25 ms, 05=30 ms)		

REMOTE CONTROL

Remote control (CI-V) information

◇ Command table

Cmd.	Sub cmd.	Data	Description	
1A*	05	SET > Function		
		0039	00 ~ 05	Send/read the TX Delay (50 MHz) setting (00=OFF, 01=10 ms, 02=15 ms, 03=20 ms, 04=25 ms, 05=30 ms)
		0041	00 ~ 05	Send/read the TX Delay (144 MHz) setting (00=OFF, 01=10 ms, 02=15 ms, 03=20 ms, 04=25 ms, 05=30 ms)
		0042	00 ~ 05	Send/read the TX Delay (430 MHz) setting (00=OFF, 01=10 ms, 02=15 ms, 03=20 ms, 04=25 ms, 05=30 ms)
		0043	00 ~ 05	Send/read the Time-Out Timer setting (00=OFF, 01=3 min, 02=5 min, 03=10 min, 04=20 min, 05=30 min)
		0044	00/01	Send/read the PTT Lock setting (00=OFF, 01=ON)
		0045	00/01	SPLIT > Send/read the Quick SPLIT setting (00=OFF, 01=ON)
		0046	See p. 20.	SPLIT > Send/read the SPLIT Offset setting
		0047	00/01	SPLIT > Send/read the SPLIT LOCK setting (00=OFF, 01=ON)
		0048	00/01	Tuner > Send/read the PTT Start setting (00=OFF, 01=ON)
		0049	00 ~ 02	Send/read the Auto Repeater setting (00=OFF, 01=ON (DUP), 02=ON (DUP,TONE))
		0050	00 ~ 02	Send/read the RTTY Mark Frequency setting (00=1275 Hz, 01=1615 Hz, 02=2125 Hz)
		0051	00 ~ 02	Send/read the RTTY Shift Width setting (00=170 Hz, 01=200 Hz, 02=425 Hz)
		0052	00/01	Send/read the RTTY Keying Polarity setting (00=Normal, 01=Reverse)
		0053	00/01	SPEECH > Send/read the SPEECH Language setting (00=Japanese, 01=English)
		0054	00/01	SPEECH > Send/read the Alphabet setting (00=Normal, 01=Phonetic Code)
		0055	00/01	SPEECH > Send/read the SPEECH Speed setting (00=Slow, 01=Fast)
0056	00 ~ 02	SPEECH > Send/read the RX Call Sign SPEECH setting (00=OFF, 01=ON (Kerchunk), 02=ON (All))		

Cmd.	Sub cmd.	Data	Description		
1A*	05	SET > Function			
		0057	00/01	SPEECH > Send/read the RX>CS SPEECH setting (00=OFF, 01=ON)	
		0058	00/01	SPEECH > Send/read the MIC Up/Down SPEECH setting (00=OFF, 01=ON)	
		0059	00/01	SPEECH > Send/read the S-Level SPEECH setting (00=OFF, 01=ON)	
		0060	00/01	SPEECH > Send/read the MODE SPEECH setting (00=OFF, 01=ON)	
		0061	0000 ~ 0255	SPEECH > Send/read the SPEECH Level setting (0000=0% ~ 0255=100%)	
		0062	00/01	Send/read the [SPEECH/LOCK] Switch setting (00=SPEECH/LOCK, 01=LOCK/SPEECH)	
		0063	00/01	Send/read the Lock Function setting (00=MAIN DIAL, 01=PANEL)	
		0064	00/01	Send/read the Memo Pad Quantity setting (00=5 ch, 01=10 ch)	
		0065	00 ~ 02	Send/read the MAIN DIAL Auto TS setting (00=OFF, 01=Low, 02=High)	
		0066	00/01	Send/read the MIC Up/Down Speed setting (00=Slow, 01=Fast)	
		0067	00 ~ 02	Send/read the [NOTCH] Switch (SSB) setting (00=Auto, 01=Manual, 02=Auto/Manual)	
		0068	00 ~ 02	Send/read the [NOTCH] Switch (AM) setting (00=Auto, 01=Manual, 02=Auto/Manual)	
		0069	00/01	Send/read the SSB/CW Synchronous Tuning setting (00=OFF, 01=ON)	
		0070	00/01	Send/read the CW Normal Side setting (00=LSB, 01=USB)	
		0071	00/01	Send/read the Charging (Power ON) setting (00=OFF, 01=ON)	
		0072	00/01	Send/read the USB Power Input (Phone, Tablet, PC) setting (00=OFF, 01=ON)	
		0073	00/01	Send/read the Power OFF Setting (for Remote Control) setting (00=Shutdown only, 01=Standby/Shutdown)	
		SET > Function > Remote MIC Key			
		0074	See p. 21.	Send/read the [A] setting	
		0075	See p. 21.	Send/read the [B] setting	
		0076	See p. 21.	Send/read the [△] setting	
		0077	See p. 21.	Send/read the [▽] setting	

REMOTE CONTROL

Remote control (CI-V) information

◇ Command table

Cmd.	Sub cmd.	Data	Description	
1A*	05	SET > Function > Remote MIC Key		
		0078	00/01	Send/read the Mode Select (SSB) setting (00=OFF, 01=ON)
		0079	00/01	Send/read the Mode Select (CW) setting (00=OFF, 01=ON)
		0080	00/01	Send/read the Mode Select (RTTY) setting (00=OFF, 01=ON)
		0081	00/01	Send/read the Mode Select (AM) setting (00=OFF, 01=ON)
		0082	00/01	Send/read the Mode Select (FM) setting (00=OFF, 01=ON)
		0083	00/01	Send/read the Mode Select (DV) setting (00=OFF, 01=ON)
		0084	00/01	Send/read the Mode Select (WFM) setting (00=OFF, 01=ON)
	SET > Function			
	0085	00/01	Send/read the Keyboard Type setting (00=Ten-key, 01=Full Keyboard)	
	0086	00 ~ 02	Send/read the Full Keyboard Layout setting (00=English, 01=German, 02=French)	
	0087	00/01	Send/read the Screen Capture [POWER] Switch setting (00=OFF, 01=ON)	
	0088	00/01	Send/read the Screen Capture File Type setting (00=PNG, 01=BMP)	
	0089	0000 ~ 0255	Send/read the REF Adjust setting (0000=0% ~ 0255=100%)	
	SET > DV Set			
	0090	00 ~ 03	Send/read the Standby Beep setting (00=OFF, 01=ON, 02=ON (to me:High Tone), 03=ON (to me:Alarm/High Tone))	
	0091	00 ~ 03	Send/read the Auto Reply setting (00=OFF, 01=ON, 02=Voice, 03=Position)	
	0092	00/01	Send/read the DV Data TX setting (00=PTT, 01=Auto)	
	0093	00/01	DV Fast Data > Send/read the Fast Data setting (00=OFF, 01=ON)	
	0094	00/01	DV Fast Data > Send/read the GPS Data Speed setting (00=Slow, 01=Fast)	
	0095	00 ~ 10	DV Fast Data > Send/read the TX Delay (PTT) setting (00=OFF, 01=1sec ~ 10=10sec)	
	0096	00 ~ 02	Send/read the Digital Monitor setting (00=Auto, 01=Digital, 02=Analog)	

Cmd.	Sub cmd.	Data	Description		
1A*	05	SET > DV Set			
		0097	00/01	Send/read the Digital Repeater Set setting (00=OFF, 01=ON)	
		0098	00/01	Send/read the DV Auto Detect setting (00=OFF, 01=ON)	
		0099	00/01	Send/read the RX Record (RPT) setting (00=ALL, 01=Latest Only)	
		0100	00/01	Send/read the BK setting (00=OFF, 01=ON)	
		0101	00/01	Send/read the EMR setting (00=OFF, 01=ON)	
		0102	0000 ~ 0255	Send/read the EMR AF Level setting (0000=0% ~ 0255=100%)	
		SET > QSO/RX Log			
		0103	00/01	Send/read the QSO Log setting (00=OFF, 01=ON)	
		0104	00/01	Send/read the RX History Log setting (00=OFF, 01=ON)	
		0105	00 ~ 02	CSV Format > Send/read the Separator/Decimal setting (00=Separator is “,” and Decimal is “.”, 01=Separator is “;” and Decimal is “.,” 02=Separator is “;” and Decimal is “,”)	
		0106	00 ~ 02	CSV Format > Send/read the Date setting (00=“yyyy/mm/dd,” 01=“mm/dd/yyyy,” 02=“dd/mm/yyyy”)	
	SET > Connectors				
	0107	00 ~ 02	Send/read the SP Jack Function setting (00=Speaker, 01=Phone, 02=Phone (L+R))		
	0108	00 ~ 30	Send/read the Phones Level setting (00=-15 ~ 30=+15)		
	0109	00/01	USB AF/IF Output > Send/read the Output Select setting (00=AF, 01=IF)		
	0110	0000 ~ 0255	USB AF/IF Output > Send/read the AF Output Level setting (0000=0% ~ 0255=100%)		
	0111	00/01	USB AF/IF Output > Send/read the AF SQL setting (00=OFF (Open), 01=ON)		
	0112	00/01	USB AF/IF Output > Send/read the AF Beep/Speech... Output setting (00=OFF, 01=ON)		
	0113	0000 ~ 0255	USB AF/IF Output > Send/read the IF Output Level setting (0000=0% ~ 0255=100%)		
	0114	00/01	WLAN AF/IF Output > Send/read the Output Select setting (00=AF, 01=IF)		
	0115	00/01	WLAN AF/IF Output > Send/read the AF SQL setting (00=OFF (Open), 01=ON)		

REMOTE CONTROL

Remote control (CI-V) information

◇ Command table

Cmd.	Sub cmd.	Data	Description	
1A*	05	SET > Connectors		
		0116	0000 ~ 0255	MOD Input > Send/read the USB MOD Level setting (0000=0% ~ 0255=100%)
		0117	0000 ~ 0255	MOD Input > Send/read the WLAN MOD Level setting (0000=0% ~ 0255=100%)
		0118	00 ~ 03	MOD Input > Send/read the DATA OFF MOD setting (00=MIC, 01=USB, 02=MIC, USB, 03=WLAN)
		0119	00 ~ 03	MOD Input > Send/read the DATA MOD setting (00=MIC, 01=USB, 02=MIC, USB, 03=WLAN)
		0120	00/01	SEND Output > Send/read the HF setting (00=OFF, 01=ON)
		0121	00/01	SEND Output > Send/read the 50M setting (00=OFF, 01=ON)
		0123	00/01	SEND Output > Send/read the 144M setting (00=OFF, 01=ON)
		0124	00/01	SEND Output > Send/read the 430M setting (00=OFF, 01=ON)
		0125	00 ~ 04	USB SEND/Keying > Send/read the USB SEND setting (00=OFF, 01=USB (A) DTR, 02=USB (A) RTS, 03=USB (B) DTR, 04=USB (B) RTS) ① You cannot select the terminal which is already selected in the "USB Keying (CW)" or "USB Keying (RTTY)" item.
		0126	00 ~ 04	USB SEND/Keying > Send/read the USB Keying (CW) setting (00=OFF, 01=USB (A) DTR, 02=USB (A) RTS, 03=USB (B) DTR, 04=USB (B) RTS) ① You cannot select the terminal which is already selected in the "USB SEND" or "USB Keying (RTTY)" item.
		0127	00 ~ 04	USB SEND/Keying > Send/read the USB Keying (RTTY) setting (00=OFF, 01=USB (A) DTR, 02=USB (A) RTS, 03=USB (B) DTR, 04=USB (B) RTS) ① You cannot select the terminal which is already selected in the "USB SEND" or "USB Keying (CW)" item.
		0128	00/01	External Keypad > Send/read the VOICE setting (00=OFF, 01=ON)

Cmd.	Sub cmd.	Data	Description		
1A*	05	SET > Connectors			
		0129	00/01	External Keypad > Send/read the KEYSER setting (00=OFF, 01=ON)	
		0130	00/01	External Keypad > Send/read the RTTY setting (00=OFF, 01=ON)	
		0131	00/01	CI-V > Send/read the CI-V Transceive setting (00=OFF, 01=ON)	
		0132	00/01	CI-V > Send/read the CI-V USB Echo Back setting (00=OFF, 01=ON)	
		0133	00 ~ 03	USB (B) Function > Send/read the USB (B) Function setting (00=OFF, 01=RTTY Decode, 02=DV Data, 03=Weather)	
		0134	00/01	USB (B) Function > Send/read the GPS Out setting (00=OFF, 01=ON) ① It is valid when "USB (B) Function" is set to "OFF" or "DV Data."	
		0135	00/01	Send/read the MIC Jack 8V Output setting (00=OFF, 01=ON)	
		SET > Display			
		0136	0000 ~ 0255	Send/read the LCD Backlight setting (0000=0% ~ 0255=100%)	
		0137	00/01	Send/read the LCD Backlight Auto Adjust setting (00=OFF, 01=ON)	
		0138	00 ~ 06	Send/read the Screen Saver (Battery Pack) setting (00=OFF, 01=1min, 02=2min, 03=5min, 04=15min, 05=30min, 06=60min)	
		0139	00 ~ 06	Send/read the Screen Saver (DC 13.8 V) setting (00=OFF, 01=1min, 02=2min, 03=5min, 04=15min, 05=30min, 06=60min)	
		0140	00/01	Send/read the Screen OFF [POWER] Switch setting (00=OFF, 01=ON)	
		0141	00/01	Send/read the RX LED setting (00=OFF, 01=ON)	
		0142	00/01	Send/read the Meter Peak Hold setting (00=OFF, 01=ON)	
		0143	00/01	Send/read the Memory Name setting (00=OFF, 01=ON)	
		0144	00/01	Send/read the Group Name Popup setting (00=OFF, 01=ON)	

REMOTE CONTROL

Remote control (CI-V) information

◇ Command table

Cmd.	Sub cmd.	Data	Description	
1A*	05	SET > Display		
		0145	00 ~ 03	Send/read the RX Call Sign Display setting (00=OFF, 01=Normal, 02=RX Hold, 03=Hold)
		0146	00/01	Send/read the RX Position Indicator setting (00=OFF, 01=ON)
		0147	00/01	Send/read the RX Position Display setting (00=OFF, 01=ON)
		0148	00 ~ 04	Send/read the RX Position Display Timer setting (00=5sec, 01=10sec, 02=15sec, 03=30sec, 04=Hold)
		0149	00/01	Send/read the Reply Position Display setting (00=OFF, 01=ON)
		0150	00/01	Send/read the RX Picture Indicator setting (00=OFF, 01=ON)
		0151	00/01	Send/read the DV RX Backlight setting (00=OFF, 01=ON)
		0152	00 ~ 02	Send/read the TX Call Sign Display setting (00=OFF, 01=Your Call Sign, 02=My Call Sign)
		0153	00/01	Send/read the Scroll Speed setting (00=Slow, 01=Fast)
		0154	00/01	Send/read the Opening Message setting (00=OFF, 01=ON)
		0155	00/01	Send/read the Power ON Check setting (00=OFF, 01=ON)
		0156	00 ~ 02	Display Unit > Send/read the Latitude/Longitude setting (00=ddd°mm.mm', 01=ddd°mm'ss", 02=ddd.dddd°)
		0157	00/01	Display Unit > Send/read the Altitude/Distance setting (00=m, 01=ft/mi)
		0158	00 ~ 02	Display Unit > Send/read the Speed setting (00=km/h, 01=mph, 02=knots)
		0159	00/01	Display Unit > Send/read the Temperature setting (00=°C, 01=°F)
		0160	00 ~ 03	Display Unit > Send/read the Barometric setting (00=hPa, 01=mb, 02=mmHg, 03=inHg)
		0161	00/01	Display Unit > Send/read the Rainfall setting (00=mm, 01=inch)
		0162	00 ~ 03	Display Unit > Send/read the Wind Speed setting (00=m/s, 01=km/h, 02=mph, 03=knots)
		0163	00/01	Send/read the Display Language setting (00=English, 01=Japanese)
0164	00/01	Send/read the System Language setting (00=English, 01=Japanese)		

Cmd.	Sub cmd.	Data	Description	
1A*	05	SET > Time Set		
		0165	20200101 ~ 20991231	Date/Time > Send/read the Date setting (20200101=2020/1/1~ 20991231=2099/12/31)
		0166	0000 ~ 2359	Date/Time > Send/read the Time setting (0000=00:00 ~ 2359=23:59)
		0167	00/01	Date/Time > Send/read the NTP Function setting (00=OFF, 01=ON)
		0168	See p. 19.	Date/Time > Send/read the NTP Server Address setting (Up to 64 characters)
		0169	00/01	Date/Time > Send/read the GPS Time Correct setting (00=OFF, 01=Auto)
		0170	See p. 21.	Send/read the UTC Offset setting
		SET > SD Card		
		0171	00 ~ 02	Import/Export > CSV Format > Send/read the Separator/Decimal setting (00=Separator is " , " and Decimal is " . " , 01=Separator is " ; " and Decimal is " . " , 02=Separator is " ; " and Decimal is " , ")
		0172	00 ~ 02	Import/Export > CSV Format > Send/read the Date setting (00="yyyy/mm/dd," 01="mm/dd/yyyy," 02="dd/mm/yyyy")
		SCOPE > SCOPE SET		
		0173	00/01	Send/read the Scope during Tx (CENTER Type) setting (00=OFF, 01=ON)
		0174	00 ~ 02	Send/read the Max Hold setting (00=OFF, 01=10s Hold, 02=ON)
		0175	00 ~ 02	Send/read the CENTER Type Display setting (00=Filter Center, 01=Carrier Point Center, 02=Carrier Point Center (Abs. Freq.))
		0176	00/01	Send/read the Marker Position (FIX Type/SCROLL Type) setting (00=Filter Center, 01=Carrier Point)
		0177	00/01	Send/read the VBW setting (00=Narrow, 01=Wide)
		0178	00 ~ 03	Send/read the Averaging setting (00=OFF, 01=2, 02=3, 03=4)
		0179	00/01	Send/read the Waveform Type setting (00=Fill, 01=Fill+Line)
		0180	See p. 21.	Send/read the Waveform Color (Current) setting
		0181	See p. 21.	Send/read the Waveform Color (Line) setting
0182	See p. 21.	Send/read the Waveform Color (Max Hold) setting		
0183	00/01	Send/read the Waterfall Display setting (00=OFF, 01=ON)		

REMOTE CONTROL

Remote control (CI-V) information

◇ Command table

Cmd.	Sub cmd.	Data	Description	
1A*	05	SCOPE > SCOPE SET		
		0184	00 ~ 02	Send/read the Waterfall Speed setting (00=Slow, 01=Mid, 02=Fast)
		0185	00 ~ 02	Send/read the Waterfall Size (Expand Screen) setting (00=Small, 01=Mid, 02=Large)
		0186	00 ~ 07	Send/read the Waterfall Peak Color Level setting (00=Grid1 ~ 07=Grid8)
		0187	00/01	Send/read the Waterfall Marker Auto-hide setting (00=OFF, 01=ON)
		0188	See p. 21.	FIX Edges > 0.03 - 1.60 > Send/read the No.1 setting
		0189	See p. 21.	FIX Edges > 0.03 - 1.60 > Send/read the No.2 setting
		0190	See p. 21.	FIX Edges > 0.03 - 1.60 > Send/read the No.3 setting
		0191	See p. 21.	FIX Edges > 1.60 - 2.00 > Send/read the No.1 setting
		0192	See p. 21.	FIX Edges > 1.60 - 2.00 > Send/read the No.2 setting
		0193	See p. 21.	FIX Edges > 1.60 - 2.00 > Send/read the No.3 setting
		0194	See p. 21.	FIX Edges > 2.00 - 6.00 > Send/read the No.1 setting
		0195	See p. 21.	FIX Edges > 2.00 - 6.00 > Send/read the No.2 setting
		0196	See p. 21.	FIX Edges > 2.00 - 6.00 > Send/read the No.3 setting
		0197	See p. 21.	FIX Edges > 6.00 - 8.00 > Send/read the No.1 setting
		0198	See p. 21.	FIX Edges > 6.00 - 8.00 > Send/read the No.2 setting
		0199	See p. 21.	FIX Edges > 6.00 - 8.00 > Send/read the No.3 setting
		0200	See p. 21.	FIX Edges > 8.00 - 11.00 > Send/read the No.1 setting
		0201	See p. 21.	FIX Edges > 8.00 - 11.00 > Send/read the No.2 setting
		0202	See p. 21.	FIX Edges > 8.00 - 11.00 > Send/read the No.3 setting
		0203	See p. 21.	FIX Edges > 11.00 - 15.00 > Send/read the No.1 setting
0204	See p. 21.	FIX Edges > 11.00 - 15.00 > Send/read the No.2 setting		
0205	See p. 21.	FIX Edges > 11.00 - 15.00 > Send/read the No.3 setting		
0206	See p. 21.	FIX Edges > 15.00 - 20.00 > Send/read the No.1 setting		
0207	See p. 21.	FIX Edges > 15.00 - 20.00 > Send/read the No.2 setting		
0208	See p. 21.	FIX Edges > 15.00 - 20.00 > Send/read the No.3 setting		
0209	See p. 21.	FIX Edges > 20.00 - 22.00 > Send/read the No.1 setting		
0210	See p. 21.	FIX Edges > 20.00 - 22.00 > Send/read the No.2 setting		

Cmd.	Sub cmd.	Data	Description	
1A*	05	SCOPE > SCOPE SET		
		0211	See p. 21.	FIX Edges > 20.00 - 22.00 > Send/read the No.3 setting
		0212	See p. 21.	FIX Edges > 22.00 - 26.00 > Send/read the No.1 setting
		0213	See p. 21.	FIX Edges > 22.00 - 26.00 > Send/read the No.2 setting
		0214	See p. 21.	FIX Edges > 22.00 - 26.00 > Send/read the No.3 setting
		0215	See p. 21.	FIX Edges > 26.00 - 30.00 > Send/read the No.1 setting
		0216	See p. 21.	FIX Edges > 26.00 - 30.00 > Send/read the No.2 setting
		0217	See p. 21.	FIX Edges > 26.00 - 30.00 > Send/read the No.3 setting
		0218	See p. 21.	FIX Edges > 30.00 - 45.00 > Send/read the No.1 setting
		0219	See p. 21.	FIX Edges > 30.00 - 45.00 > Send/read the No.2 setting
		0220	See p. 21.	FIX Edges > 30.00 - 45.00 > Send/read the No.3 setting
		0221	See p. 21.	FIX Edges > 45.00 - 60.00 > Send/read the No.1 setting
		0222	See p. 21.	FIX Edges > 45.00 - 60.00 > Send/read the No.2 setting
		0223	See p. 21.	FIX Edges > 45.00 - 60.00 > Send/read the No.3 setting
		0224	See p. 21.	FIX Edges > 60.00 - 74.80 > Send/read the No.1 setting
		0225	See p. 21.	FIX Edges > 60.00 - 74.80 > Send/read the No.2 setting
		0226	See p. 21.	FIX Edges > 60.00 - 74.80 > Send/read the No.3 setting
		0227	See p. 21.	FIX Edges > 74.80 - 108.00 > Send/read the No.1 setting
		0228	See p. 21.	FIX Edges > 74.80 - 108.00 > Send/read the No.2 setting
		0229	See p. 21.	FIX Edges > 74.80 - 108.00 > Send/read the No.3 setting
		0230	See p. 21.	FIX Edges > 108.00 - 137.00 > Send/read the No.1 setting
0231	See p. 21.	FIX Edges > 108.00 - 137.00 > Send/read the No.2 setting		
0232	See p. 21.	FIX Edges > 108.00 - 137.00 > Send/read the No.3 setting		
0233	See p. 21.	FIX Edges > 137.00 - 200.00 > Send/read the No.1 setting		
0234	See p. 21.	FIX Edges > 137.00 - 200.00 > Send/read the No.2 setting		
0235	See p. 21.	FIX Edges > 137.00 - 200.00 > Send/read the No.3 setting		
0236	See p. 21.	FIX Edges > 400.00 - 470.00 > Send/read the No.1 setting		
0237	See p. 21.	FIX Edges > 400.00 - 470.00 > Send/read the No.2 setting		
0238	See p. 21.	FIX Edges > 400.00 - 470.00 > Send/read the No.3 setting		

REMOTE CONTROL

Remote control (CI-V) information

◇ Command table

Cmd.	Sub cmd.	Data	Description	
1A*	05	AUDIO > AUDIO SCOPE SET		
		0239	00/01	Send/read the FFT Scope Waveform Type setting (00=Line, 01=Fill)
		0240	See p. 21.	Send/read the FFT Scope Waveform Color setting
		0241	00/01	Send/read the FFT Scope Waterfall Display setting (00=OFF, 01=ON)
		0242	See p. 21.	Send/read the Oscilloscope Waveform Color setting
	VOICE			
	0243	0000 ~ 0255	Send/read the TX LEVEL setting (0000=0% ~ 0255=100%)	
	0244	00/01	VOICE TX SET > Send/read the Auto Monitor setting (00=OFF, 01=ON)	
	0245	01 ~ 15	VOICE TX SET > Send/read the Repeat Time setting (01=1sec ~ 15=15sec)	
	KEYER > KEYER 001			
	0246	00 ~ 04	Send/read the Number Style setting (00=Normal, 01=190→ANO, 02=190→ANT, 03=90→NO, 04=90→NT)	
	0247	01 ~ 08	Send/read the Count Up Trigger setting (01=M1 ~ 08=M8)	
	0248	0001 ~ 9999	Send/read Present Number setting (0001=1 ~ 9999=9999)	
	KEYER > CW-KEY SET			
	0249	0000 ~ 0255	Send/read Side Tone Level setting (0000=0% ~ 0255=100%)	
	0250	00/01	Send/read Side Tone Level Limit setting (00=OFF, 01=ON)	
	0251	01 ~ 60	Send/read Keyer Repeat Time setting (01=1sec ~ 60=60sec)	
	0252	28 ~ 45	Send/read Dot/Dash Ratio setting (28=1:1:2.8 ~ 45=1:1:4.5 in 0.1 steps)	
	0253	00 ~ 03	Send/read Rise Time setting (00=2ms, 01=4ms, 02=6ms, 03=8ms)	
	0254	00/01	Send/read Paddle Polarity setting (00=Normal, 01=Reverse)	
	0255	00 ~ 02	Send/read Key Type setting (00=Straight, 01=Bug, 02=Paddle)	
	0256	00 ~ 02	Send/read MIC Up/Down Keyer setting (00=OFF, 01=ON (UP/DOWN), 02=ON (A/B))	
	DECODE > RTTY DECODE SET			
	0257	00 ~ 03	Send/read the FFT Scope Averaging setting (00=OFF, 01=2, 02=3, 03=4)	
	0258	See p. 21.	Send/read the FFT Scope Waveform Color setting	
	0259	00/01	Send/read the Decode USOS setting (00=OFF, 01=ON)	

Cmd.	Sub cmd.	Data	Description	
1A*	05	DECODE > RTTY DECODE SET		
		0260	00/01	Send/read the Decode New Line Code setting (00=CR,LF,CR+LF, 01=CR+LF)
		0261	00/01	Send/read the TX USOS setting (00=OFF, 01=ON)
		0262	See p. 21.	Send/read the Font Color (Receive) setting
		0263	See p. 21.	Send/read the Font Color (Transmit) setting
	DECODE > RTTY DECODE LOG			
	0264	00/01	Send/read the Decode Log setting (00=OFF, 01=ON)	
	0265	00/01	Log Set > Send/read the File Type setting (00=Text, 01=HTML)	
	0266	00/01	Log Set > Send/read the Time Stamp setting (00=OFF, 01=ON)	
	0267	00/01	Log Set > Send/read the Time Stamp (Time) setting (00=Local, 01=UTC)	
	0268	00/01	Log Set > Send/read the Time Stamp (Frequency) setting (00=OFF, 01=ON)	
	RECORD > Recorder Set			
	0269	00/01	Send/read the TX REC Audio setting (00=Direct, 01= Monitor)	
	0270	00/01	Send/read the RX REC Condition setting (00=Always, 01=Squelch Auto)	
	0271	00/01	Send/read the File Split setting (00=OFF, 01=ON)	
	0272	00/01	Send/read the PTT Auto REC setting (00=OFF, 01=ON)	
	0273	00 ~ 03	Send/read the PRE-REC for PTT Auto REC setting (00=OFF, 01=5sec, 02=10sec, 03=15sec)	
	RECORD > Player Set			
	0274	00 ~ 03	Send/read the Skip Time setting (00=3sec, 01=5sec, 02=10sec, 03=30sec)	
	SCAN > SCAN SET			
	0275	00/01	Send/read the SCAN Speed setting (00=Slow, 01=Fast)	
	0276	00/01	Send/read the SCAN Resume setting (00=OFF, 01=ON)	
	0277	00 ~ 10	Send/read the Pause Timer setting (00=2sec ~ 09=20sec in 2 seconds, 10=HOLD)	
	0278	00 ~ 06	Send/read the Resume Timer setting (00=0sec ~ 05=5sec, 06=HOLD)	
	0279	00 ~ 04	Send/read the Temporary Skip Timer setting (00=5min, 01=10min, 02=15min, 03=While Scanning, 04=While Powered ON)	

REMOTE CONTROL

Remote control (CI-V) information

◇ Command table

Cmd.	Sub cmd.	Data	Description	
1A*	05	SCAN > SCAN SET		
		0280	00/01	Send/read the MAIN DIAL Operation (SCAN) setting (00=OFF, 01=Up/Down)
		GPS		
		0281	00 ~ 02	GPS Set > Send/read the GPS Select setting (00=OFF, 01=ON, 02=Manual)
		0282	00/01	GPS Set > GPS Option > Send/read the SBAS setting (00=OFF, 01=ON)
		0283	00/01	GPS Set > GPS Option > Send/read the GLONASS setting (00=OFF, 01=ON)
		0284	00 ~ 05	GPS Set > GPS Option > Send/read the Power Save setting (00=OFF, 01=1min, 02=2min, 03=4min, 04=8min, 05=Auto)
		0285	00/01	GPS Set > GPS Option > Send/read the Satellite Information Out setting (00=GPS/QZSS/GLONASS, 01=GPS Only)
		0286	See p. 22.	GPS Set > Send/read the Manual Position setting
		0287	00 ~ 02	Send/read the GPS TX Mode setting (00=OFF, 01=D-PRS, 02=NMEA)
		GPS > GPS TX Mode > D-PRS		
		0288	See p. 19.	Send/read the Unproto Address setting (Up to 56 characters)
		0289	00 ~ 03	Send/read the TX Format setting (00=Position, 01=Object, 02=Item, 03=Weather)
		GPS > GPS TX Mode > D-PRS > TX Format > Position		
		0290	00 ~ 03	Send/read the Symbol setting (00=No.1, 01=No.2, 02=No.3, 03=No.4)
		0291	See pp. 19 and 22.	Send/read the Symbol No.1 setting (2 characters)
		0292	See pp. 19 and 22.	Send/read the Symbol No.2 setting (2 characters)
		0293	See pp. 19 and 22.	Send/read the Symbol No.3 setting (2 characters)
		0294	See pp. 19 and 22.	Send/read the Symbol No.4 setting (2 characters)
		0295	00 ~ 42	Send/read the SSID setting (00= - - -, 01=(- 0), 02= -1 ~ 16= -15, 17= -A ~ 42=-Z)
		0296	00 ~ 03	Send/read the Comment setting (00=No.1, 01=No.2, 02=No.3, 03=No.4)
		0297	See p. 19.	Send/read the Comment No.1 setting (Up to 43 characters)
		0298	See p. 19.	Send/read the Comment No.2 setting (Up to 43 characters)
		0299	See p. 19.	Send/read the Comment No.3 setting (Up to 43 characters)
		0300	See p. 19.	Send/read the Comment No.4 setting (Up to 43 characters)

Cmd.	Sub cmd.	Data	Description	
1A*	05	GPS > GPS TX Mode > D-PRS > TX Format > Position		
		0301	00 ~ 02	Send/read the Time Stamp setting (00=OFF, 01=DHM, 02=HMS)
		0302	00/01	Send/read the Altitude setting (00=OFF, 01=ON)
		0303	00 ~ 02	Send/read the Data Extension setting (00=OFF, 01=Course/Speed, 02=Power/Height/Gain/Directivity)
		0304	00 ~ 09	Send/read the Power setting (00=0W, 01=1W, 02=4W, 03=9W, 04=16W, 05=25W, 06=36W, 07=49W, 08=64W, 09=81W)
		0305	00 ~ 09	Send/read the Height setting (00=3m, 01=6m, 02=12m, 03=24m, 04=49m, 05=98m, 06=195m, 07=390m, 08=780m, 09=1561m)
		0306	00 ~ 09	Send/read the Gain setting (00=0dB ~ 09=9dB)
		0307	00 ~ 08	Send/read the Directivity setting (00=Omni, 01=45°NE, 02=90°E, 03=135°SE, 04=180°S, 05=225°SW, 06=270°W, 07=315°NW, 08=360°N)
		GPS > GPS TX Mode > D-PRS > TX Format > Object		
		0308	See p. 19.	Send/read the Object Name setting (Up to 9 characters)
		0309	00/01	Send/read the Data Type setting (00=Live Object, 01=Kill Object)
		0310	See pp. 19 and 22.	Send/read the Symbol setting (2 characters)
		0311	See p. 19.	Send/read the Comment setting (Up to 43 characters)
		0312	See p. 22.	Send/read the Position setting
		0313	00 ~ 02	Send/read the Data Extension setting (00=OFF, 01=Course/Speed, 02=Power/Height/Gain/Directivity)
		0314	000 ~ 360	Send/read the Course setting (000=0° ~ 360=360°)
		0315	0000 ~ 1850	Send/read the Speed setting (0000=0km/h ~ 1850=1850km/h)
		0316	00 ~ 09	Send/read the Power setting (00=0W, 01=1W, 02=4W, 03=9W, 04=16W, 05=25W, 06=36W, 07=49W, 08=64W, 09=81W)
		0317	00 ~ 09	Send/read the Height setting (00=3m, 01=6m, 02=12m, 03=24m, 04=49m, 05=98m, 06=195m, 07=390m, 08=780m, 09=1561m)
		0318	00 ~ 09	Send/read the Gain setting (00=0dB ~ 09=9dB)
		0319	00 ~ 08	Send/read the Directivity setting (00=Omni, 01=45°NE, 02=90°E, 03=135°SE, 04=180°S, 05=225°SW, 06=270°W, 07=315°NW, 08=360°N)
		0320	00 ~ 42	Send/read the SSID setting (00= - - -, 01=(- 0), 02= -1 ~ 16= -15, 17= -A ~ 42= -Z)
		0321	00/01	Send/read the Time Stamp setting (00=DHM, 01=HMS)

REMOTE CONTROL

Remote control (CI-V) information

◇ Command table

Cmd.	Sub cmd.	Data	Description	
1A*	05	GPS > GPS TX Mode > D-PRS > TX Format > Item		
		0322	See p. 19.	Send/read the Item Name setting (Up to 9 characters)
		0323	00/01	Send/read the Data Type setting (00=Live Item, 01=Killed Item)
		0324	See pp. 19 and 22.	Send/read the Symbol setting (2 characters)
		0325	See p. 19.	Send/read the Comment setting (Up to 43 characters)
		0326	See p. 22.	Send/read the Position setting
		0327	00 ~ 02	Send/read the Data Extension setting (00=OFF, 01=Course/Speed, 02=Power/Height/Gain/Directivity)
		0328	000 ~ 360	Send/read the Course setting (000 ~ 360=0° ~ 360°)
		0329	0000 ~ 1850	Send/read the Speed setting (0000=0km/h ~ 1850=1850km/h)
		0330	00 ~ 09	Send/read the Power setting (00=0W, 01=1W, 02=4W, 03=9W, 04=16W, 05=25W, 06=36W, 07=49W, 08=64W, 09=81W)
		0331	00 ~ 09	Send/read the Height setting (00=3m, 01=6m, 02=12m, 03=24m, 04=49m, 05=98m, 06=195m, 07=390m, 08=780m, 09=1561m)
		0332	00 ~ 09	Send/read the Gain setting (00=0dB ~ 09=9dB)
		0333	00 ~ 08	Send/read the Directivity setting (00=Omni, 01=45°NE, 02=90°E, 03=135°SE, 04=180°S, 05=225°SW, 06=270°W, 07=315°NW, 08=360°N)
	0334	00 ~ 42	Send/read the SSID setting (00= - - -, 01=(- 0), 02= -1 ~ 16= -15, 17= -A ~ 42= -Z)	
	GPS > GPS TX Mode > D-PRS > TX Format > Weather			
	0335	See pp. 19 and 22.	Send/read the Symbol setting (2 characters)	
	0336	00 ~ 42	Send/read the SSID setting (00= - - -, 01=(- 0), 02= -1 ~ 16= -15, 17= -A ~ 42= -Z)	
	0337	See p. 19.	Send/read the Comment setting (Up to 43 characters)	
	0338	00 ~ 02	Send/read the Time Stamp setting (00=OFF, 01=DHM, 02=HMS)	
	GPS > GPS TX Mode > NMEA			
	0339*6	00/01	GPS Sentence > Send/read the RMC setting (00=OFF, 01=ON)	
	0340*6	00/01	GPS Sentence > Send/read the GGA setting (00=OFF, 01=ON)	
	0341*6	00/01	GPS Sentence > Send/read the GLL setting (00=OFF, 01=ON)	

Cmd.	Sub cmd.	Data	Description		
1A*	05	GPS > GPS TX Mode > NMEA			
		0342*6	00/01	GPS Sentence > Send/read the GSA setting (00=OFF, 01=ON)	
		0343*6	00/01	GPS Sentence > Send/read the VTG setting (00=OFF, 01=ON)	
		0344*6	00/01	GPS Sentence > Send/read the GSV setting (00=OFF, 01=ON)	
		0345	See p. 19.	Send/read the GPS Message setting (Up to 20 characters)	
		GPS > GPS Alarm			
		0346	See p. 22.	Send/read the Alarm Area (Group) setting	
		0347	00 ~ 02	Send/read the Alarm Area (RX/Memory) setting (00=Limited, 01=Extended, 02=Both)	
		GPS > GPS Logger			
		0348	00/01	Send/read the GPS Logger setting (00=OFF, 01=ON)	
		0349	00 ~ 06	Send/read the Record Interval setting (00=1sec, 01=5sec, 02=10sec, 03=30sec, 04=1min, 05=5min, 06=10min)	
		0350	00/01	Record Sentence > Send/read the RMC setting (00=OFF, 01=ON)	
		0351	00/01	Record Sentence > Send/read the GGA setting (00=OFF, 01=ON)	
	0352	00/01	Record Sentence > Send/read the VTG setting (00=OFF, 01=ON)		
	0353	00/01	Record Sentence > Send/read the GSA setting (00=OFF, 01=ON)		
	GPS				
	0354	00 ~ 06	Send/read the GPS Auto TX setting (00=OFF, 01=30sec, 02=1min, 03=3min, 04=5min, 05=10min, 06=30min)		
	DTMF > DTMF SET				
	0355	00 ~ 03	Send/read the DTMF Speed setting (00=100ms, 01=200ms, 02=300ms, 03=500ms)		
	NB				
	0356	0000 ~ 0255	Send/read the NB LEVEL setting (0000=0% ~ 0255=100%)		
	0357	00 ~ 09	Send/read the NB DEPTH setting (00=1 ~ 09=10)		
	0358	0000 ~ 0255	Send/read the NB WIDTH setting (0000=1 ~ 0255=100)		

REMOTE CONTROL

Remote control (CI-V) information

◇ Command table

Cmd.	Sub cmd.	Data	Description
1A*	05	VOX	
		0359	00 ~ 20 Send/read the VOX DELAY setting (00=0.0s ~ 20=2.0s in 0.1s steps)
		0360	00 ~ 03 Send/read the VOICE DELAY setting (00=OFF, 01=SHORT, 02=MID, 03=LONG)
		CD	
		0361	00/01 Send/read the Call Sign Display/Name Display setting (00=Call Sign Display, 01=Name Display)
		GPS Position	
		0362	00 ~ 02 Send/read the Compass Direction setting (00=Heading Up, 01=North Up, 02=South Up)
		SET > Function	
		0363	00/01 Send/read the Battery Pack Select setting (00=BP-272, 01=BP-307)
		0364	00/01 Send/read the Battery Pack Confirmation setting (00=OFF, 01=ON)
		SET > Function > Tuner	
		0365	00/01 Send/read the Tuner Select setting (00=AH-705, 01=Others)
		0366	00/01 AH-705 > Send/read the Tune Memory setting (00=OFF, 01=ON)
		SET > Function > Front Key Customize	
		0367	See p. 21. Send/read the [VOX/BK-IN] setting
		0368	See p. 22. Send/read the [AUTOTUNE/RX>CS] setting
		SCOPE > SCOPE SET	
		0369	See p. 21. FIX Edges > 0.03 - 1.60 > Send/read the No.4 setting
		0370	See p. 21. FIX Edges > 1.60 - 2.00 > Send/read the No.4 setting
		0371	See p. 21. FIX Edges > 2.00 - 6.00 > Send/read the No.4 setting
		0372	See p. 21. FIX Edges > 6.00 - 8.00 > Send/read the No.4 setting
		0373	See p. 21. FIX Edges > 8.00 - 11.00 > Send/read the No.4 setting
		0374	See p. 21. FIX Edges > 11.00 - 15.00 > Send/read the No.4 setting
		0375	See p. 21. FIX Edges > 15.00 - 20.00 > Send/read the No.4 setting
		0376	See p. 21. FIX Edges > 20.00 - 22.00 > Send/read the No.4 setting
		0377	See p. 21. FIX Edges > 22.00 - 26.00 > Send/read the No.4 setting
		0378	See p. 21. FIX Edges > 26.00 - 30.00 > Send/read the No.4 setting

Cmd.	Sub cmd.	Data	Description
1A*	05	SCOPE > SCOPE SET	
		0379	See p. 21. FIX Edges > 30.00 - 45.00 > Send/read the No.4 setting
		0380	See p. 21. FIX Edges > 45.00 - 60.00 > Send/read the No.4 setting
		0381	See p. 21. FIX Edges > 60.00 - 74.80 > Send/read the No.4 setting
		0382	See p. 21. FIX Edges > 74.80 - 108.00 > Send/read the No.4 setting
		0383	See p. 21. FIX Edges > 108.00 - 137.00 > Send/read the No.4 setting
		0384	See p. 21. FIX Edges > 137.00 - 200.00 > Send/read the No.4 setting
		0385	See p. 21. FIX Edges > 400.00 - 470.00 > Send/read the No.4 setting
		06	See p. 22. Send/read the DATA mode setting
		07	00/01 Send/read the NTP server access (00=Terminate, 01=Initiate)
	08*1	00 ~ 02 Read NTP server access result (00=Accessing, or have not accessed after Power ON, 01=Succeeded, 02=Failed)	
	09*1	00/01 Read the OVF indicator status (00=OFF, 01=ON)	
	0A	00 ~ 02 Send/read the Share Pictures function status (00=OFF, 01=ON, 02=ON (Repeat)) ① While transmitting the picture using the DV Fast Data function, sends ON even if the status is set to OFF.	
	0B*1	00/01 Read the type of power supply based on the current voltage (00=External power supply, 01=Battery pack)	
	1B*	00	See p. 22. Send/read the Repeater tone frequency
		01	See p. 22. Send/read the TSQL tone frequency
		02	See p. 22. Send/read the DTCS code and polarity
		07	See p. 23. Send/read the CSQ code (DV mode)
1C	00*	00/01 Send/read the transceiver's status (00=RX, 01=TX)	
	01*	00 ~ 02 Send/read the Antenna tuner's status (00=OFF, 01=ON, 02=Tune)	
	02*	00/01 Send/read the Transmit frequency monitor (XFC) (00=OFF, 01=ON)	
	03*1	See p. 17. Read the transmit frequency	
1E	00*1	Read number of available TX frequency band	
	01*1	See p. 17. Read TX band edge frequencies	
	02*1	Read number of user-set TX frequency band	
	03*	See p. 17. Send/read the user-set TX band edge frequencies	

REMOTE CONTROL

Remote control (CI-V) information

◇ Command table

Cmd.	Sub cmd.	Data	Description
1F*	00	See p. 23.	SET > My Station > Send/read the My Call Sign setting
	01	See p. 23.	CS > Send/read the UR, R1, R2 setting
	02	See p. 23.	SET > My Station > Send/read the TX Message setting
20	00	00*	00/01*7 Send/read the Auto DV RX Call signs output (00=OFF, 01=ON)
		01	See p. 23. Output DV RX Call signs for transceiver
		02*1	See p. 23. Read Auto DV RX Call signs
	01	00*	00/01*7 Send/read the Auto DV RX message output (00=OFF, 01=ON)
		01	See p. 24. Output DV RX message for transceiver
		02*1	See p. 24. Read Auto DV RX message
	02	00*	00/01*7 Send/read the Auto DV RX status output (00=OFF, 01=ON)
		01	See p. 24. Output DV RX status for transceiver
		02*1	See p. 24. Read Auto DV RX status
	03	00*	00/01 Send/read the Auto DV RX GPS/D-PRS data output (00=OFF, 01=ON)
		0100	See p. 24. Output DV RX GPS/D-PRS Position for transceiver
		0101	See p. 25. Output DV RX D-PRS Object status for transceiver
		0102	See p. 25. Output DV RX D-PRS Item status for transceiver
		0103	See p. 26. Output DV RX D-PRS Weather status for transceiver
		0200*1	See p. 24. Read Auto DV RX GPS/D-PRS Position status
		0201*1	See p. 25. Read Auto DV RX D-PRS Object status
		0202*1	See p. 25. Read Auto DV RX D-PRS Item status
		0203*1	See p. 26. Read Auto DV RX D-PRS Weather status
	04	00*	00/01 Send/read Auto DV RX GPS/D-PRS message output (00=OFF, 01=ON)
		01	See p. 26. Output DV RX D-PRS message for transceiver
02*1		See p. 26. Read Auto DV RX D-PRS message status	
21*	00	See p. 26.	Send/read the RIT frequency
	01	00/01	Send/read the RIT setting (00=OFF, 01=ON)
	02	00/01	Send/read the ΔTX setting (00=OFF, 01=ON)

Cmd.	Sub cmd.	Data	Description
22	00	See p. 26.	Set the DV TX data (Up to 30 byte)
	01	00*	00/01 Set the Auto DV RX data output (00=OFF, 01=ON)
		01	See p. 26.
	02*	00/01	SET > DV Set > Send/read the DV Data TX setting (00=PTT, 01=Auto)
	03*	00/01	SET > DV Set > DV Fast Data > Send/read the Fast Data setting (00=OFF, 01=ON)
	04*	00/01	SET > DV Set > DV Fast Data > Send/read the GPS Data Speed setting (00=Slow, 01=Fast)
05*	00 ~ 10	SET > DV Set > DV Fast Data > Send/read the TX Delay (PTT) setting (00=OFF, 01=1sec ~ 10=10sec)	
23	00*1	See p. 26.	Read the position status
	01*	00/01/03	GPS > GPS Set > Send/read the GPS Select setting (00=OFF, 01=ON, 03=Manual)
	02*	See p. 22.	GPS > GPS Set > Send/read the Manual Position setting
24	00	00*	00/01 Send/read TX output power setting (00=OFF, 01=ON)
		01	00/01 Set the TX output power for transceiver (00=OFF, 01=ON)
25*		See p. 27.	Send/read the selected or unselected VFO frequency
26*		See p. 27.	Send/read the selected or unselected VFO's operating mode and filter
27*	00	See p. 27.	Read the Scope waveform data (Only when "Scope ON/OFF status" (Command: 27 10) and "Scope data output" (Command: 27 11) are set to "ON," outputs the waveform data to the controller.)
	10	00/01	Send/read the Scope ON/OFF status (00=OFF, 01=ON)
	11	00/01	Send/read the Scope wave data output (00=OFF, 01=ON)
	12	00	Send/read the Main or Sub scope setting (00=Main (fixed))
	13	00	Send/read the Single/Dual scope setting (00=Single (fixed))
	14	0000 ~ 0003	Send/read the Scope Center mode, Fixed mode, SCROLL-C mode, or SCROLL-F mode setting (0000=CENTER mode, 0001=FIX mode, 0002=SCROLL-C mode, 0003=SCROLL-F mode)
	15	See p. 28.	Send/read the Span setting in the Center mode or SCROLL-C mode Scope
	16	0001 ~ 0004	Send/read the Edge number setting in the Fixed mode or SCROLL-F mode Scope

REMOTE CONTROL

Remote control (CI-V) information

◇ Command table

Cmd.	Sub cmd.	Data	Description
27*	17	0000/ 0001	Send/read the Scope hold function ON/OFF status (0000=OFF, 0001=ON)
	19	See p. 28.	Send/read the Scope Reference level setting
	1A	0000 ~ 0002	Send/read the Sweep speed setting (0000=FAST, 0001=MID, 0002=SLOW)
	1B	00/01	SCOPE > SCOPE SET > Send/read the Scope during Tx (CENTER TYPE) setting (00=OFF, 01=ON)
	1C	00 ~ 02	SCOPE > SCOPE SET > Send/read the CENTER Type Display setting (00=Filter Center, 01=Carrier Point Center, 02=Carrier Point Center (Abs. Freq.))
	1D	0000/ 0001	Send/read the Scope VBW setting (0000=NAR, 0001=WIDE)
	1E	See p. 28.	Send/read the Scope Fixed edge frequencies
	20	00/01	SCOPE > SCOPE SET > Send/read Marker Position (FIX Type/SCROLL Type) setting (00=Filter Center, 01=Carrier Point)
28	00	00 ~ 08	Transmit the Voice TX Memory (00=Stop, 01=T1 ~ 08=T8)

*(Asterisk) Send/read data

*1 Read only data

*2 Send only data

*3 In the CW mode, if the [PTT] or an external TX switch is ON, or the Break-in function is ON, a message will be transmitted as CW code when you send it from your PC.

*4 Sending the power ON command (18 01) turns ON the transceiver when the transceiver is OFF (Standby/Shutdown).

*5 To insert a counter, first clear the other channel's counter.

*6 Set at least 1 GPS sentence to ON.

Up to 4 GPS sentences can be set to ON at the same time.

*7 Output setting is automatically set to OFF after turning OFF the transceiver.

Remote control (CI-V) information

◇ Command formats

• Operating frequency

Command: 00, 03, 05, 1C 03

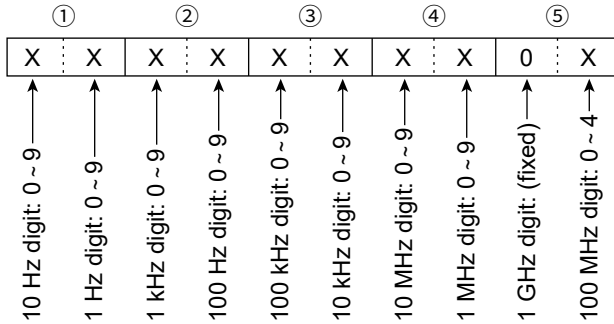

• Duplex Offset frequency setting

Command: 0C, 0D

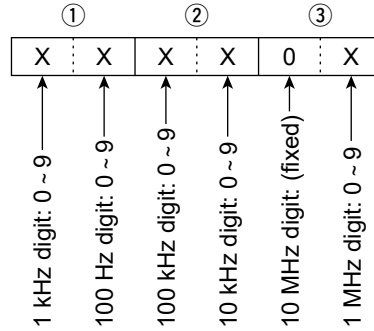

• Operating mode

Command: 01, 04, 06

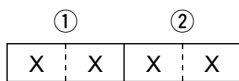

① Operating mode		② Filter setting
00: LSB	05: FM	01: FIL1
01: USB	06: WFM	02: FIL2
02: AM	07: CW-R	03: FIL3
03: CW	08: RTTY-R	—
04: RTTY	17: DV	—

① Filter setting, (②) can be skipped with command 01 and 06. In that case, "FIL1" is selected with command 01 and the default filter setting of the operating mode is automatically selected with command 06.

• Band edge frequency settings

Command: 02*, 1E 01, 1E 03

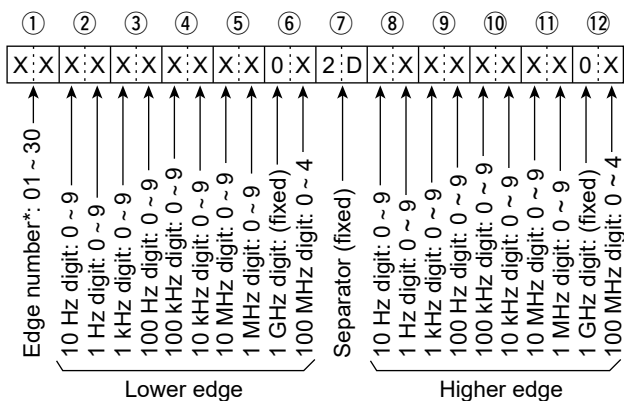

* When obtaining the edge number (by command "02"), the edge number (①) is not returned.

• Codes for CW message contents

Command: 17 (Up to 30 characters)

To send CW messages, use the following character codes.

Character	ASCII code	Character	ASCII code
0 ~ 9	30 ~ 39	'	27
A ~ Z	41 ~ 5A	(28
a ~ z	61 ~ 7A)	29
/	2F	=	3D
?	3F	+	2B
.	2E	"	22
-	2D	@	40
,	2C	Space	20
:	3A		

① "FF" stops sending CW messages.

① "A" is used to transmit a string of characters with no inter-character space.

Remote control (CI-V) information

◇ Command formats

• Memory content

Command: 1A 00

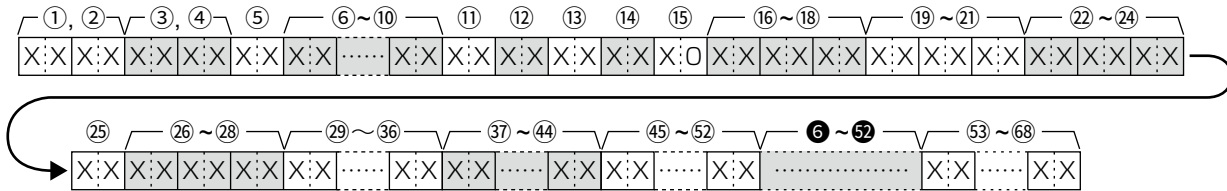

①, ②: Memory group number
 0000 ~ 0099: Memory channel group
 0100: Call channel group

③, ④: Memory channel numbers
 • When Memory channel group is selected,
 0000 ~ 0099: 00 ~ 99
 • When Call channel group is selected,
 0000, 0001: 144 C1, C2
 0002, 0003: 430 C1, C2

⑤: Split and Select memory setting

⑤	X	:	X
---	---	---	---

0=OFF*
 1=★1
 2=★2
 3=★3
 0=Split OFF, 1=Split ON

* Set 0 for Call channel.

⑥~⑩: Operating frequency setting
 ①See "Operating frequency." (p. 17)

⑪, ⑫: Operating mode setting
 ①See "Operating mode." (p. 17)

⑬: Data mode setting
 1 byte data (XX)
 00: Data mode OFF
 01: Data mode ON

⑭: Duplex and Tone settings

⑭	X	:	X
---	---	---	---

0=OFF
 1=TONE
 2=TSQL
 3=DTCS
 0=Duplex OFF
 1=Duplex-
 2=Duplex+

⑮: Digital squelch setting

⑮	X	:	0
---	---	---	---

0=Digital squelch function OFF
 1=Digital call sign squelch function ON (DSQL)
 2=Digital code squelch function ON (CSQL)

⑯~⑰: Repeater tone frequency setting
 ⑱~⑲: Repeater tone frequency setting
 ①See "Repeater tone/tone squelch frequency setting." (p. 22)

⑳~㉔: DTCS code setting
 ①See "DTCS code and polarity setting." (p. 22)

㉕: DV Digital code squelch setting
 ①See "DV Digital code squelch setting." (p. 23)

㉖~㉘: Duplex offset frequency setting
 ①See "Duplex Offset frequency setting." (p. 17)

㉙~㉜: UR (Destination) call sign setting
 (8 characters, fixed)

㉝~㉠: R1 (Access repeater) call sign setting
 (8 characters, fixed)

㉡~㉥: R2 (Gateway/Link repeater) call sign setting
 (8 characters, fixed)

①See "DV TX call signs setting." (p. 23)

㉦~㉨: Memory name setting (16 characters, fixed)
 ①See "Codes for character entries." (p. 19)

To clear the memory channel contents on 1A 00:

- ①, ②: Memory channel group (0000~0099)
 You cannot specify group "0100" (Call channel group)
- ③, ④: Memory channel (0000~0099)
- ⑤: "FF," ⑥ ~ : None

NOTE:

- The same data as ⑥ ~ ⑫ are stored in ⑥ ~ ⑫.
- When the Split function is ON, the data of ⑥ ~ ⑫ is used for transmit.
- Even if the Split function is OFF, enter the data into ⑥ ~ ⑫ to match your transceiver. We recommend that you set the same data as ⑥ ~ ⑫.

REMOTE CONTROL

Remote control (CI-V) information

◇ Command formats

• Codes for character entries

Command: 1A 00,
 1A 05 0168, 0288, 0308, 0310,
 0311, 0322, 0325, 0337,
 0345,
 1A 05 0291 ~ 1A 05 0294,
 1A 05 0297 ~ 1A 05 0300

- Character codes— Letters and Numbers

Character	ASCII code	Character	ASCII code
A ~ Z	41 ~ 5A	a ~ z	61 ~ 7A
0 ~ 9	30 ~ 39		

- Character codes— Symbols

Character	ASCII code	Character	ASCII code
!	21	#	23
\$	24	%	25
&	26	\	5C
?	3F	"	22
'	27	`	60
^	5E	+	2B
-	2D	*	2A
/	2F	.	2E
,	2C	:	3A
;	3B	=	3D
<	3C	>	3E
(28)	29
[5B]	5D
{	7B	}	7D
	7C	_	5F
~	7E	@	40

Cmd.	Sub cmd.	Set item/selectable characters
1A	00	Memory name All characters are usable.
	05 0168	NTP Server Address A ~ Z, a ~ z, 0 ~ 9, ., -

• Band stacking register

Command: 1A 01

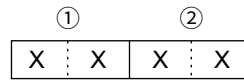

NOTE: When sending the contents, the codes, such as operating frequency and operating mode*, should be added after the frequency band code and the register code, as shown below.

* See ⑥ ~ ⑫ on “Memory content.” (p. 18)

①: Frequency band codes

Code	Freq. band	Frequency range (unit: MHz)
01	1.9	1.800000 ~ 1.999999
02	3.5	3.400000 ~ 4.099999
03	7	6.900000 ~ 7.499999
04	10	9.900000 ~ 10.499999
05	14	13.900000 ~ 14.499999
06	18	17.900000 ~ 18.499999
07	21	20.900000 ~ 21.499999
08	24	24.400000 ~ 25.099999
09	28	28.000000 ~ 29.999999
10	50	50.000000 ~ 54.000000
11	WFM	74.800000 ~ 107.999999
12	Air	108.000000 ~ 136.999999
13	144	144.000000 ~ 148.000000
14	430	420.000000 ~ 450.000000
15	GENE	Other than above

②: Register codes

Code	Registered number
01	1 (Display on left side)
02	2 (Display in center)
03	3 (Display on Right side)

To read the contents, the register code should be added after the frequency band code, as shown below.

Example: When reading the frequency displayed in the center of the display in the 21 MHz band, use code “0703.”

Remote control (CI-V) information

◇ Command formats

• **Keyer memory character entries**

Command: 1A 02

- Character codes

Character	ASCII code	Description
0 ~ 9	30 ~ 39	Numbers
A ~ Z	41 ~ 5A	Letters
Space	20	Word space
/	2F	Symbol
?	3F	Symbol
,	2C	Symbol
.	2E	Symbol
@	40	Symbol
^	5E	Example: to send \overline{BT} , enter ^4254
*	2A	Inserts the contest number (can be used for 1 channel only)

① Information

- “FA” (NG) is returned if you insert the content number in more than 1 channel.
- Spaces after the end of the sentence are not necessary.
- To clear the Keyer memory contents, send one or more spaces.

• **Keyer memory content**

Command: 1A 02

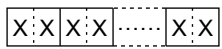

- ①: Channel data
 - 01=M1 05=M5
 - 02=M2 06=M6
 - 03=M3 07=M7
 - 04=M4 08=M8
- ② ~ ⑦: Text data

• **IF filter width settings**

Command: 1A 03

Mode	Data	Steps
SSB/CW/RTTY	0 ~ 9	50 ~ 500 Hz (50 Hz)
SSB/CW	10 ~ 40	600 Hz ~ 3.6 kHz (100 Hz)
RTTY	10 ~ 31	600 ~ 2.7 kHz (100 Hz)
AM	0 ~ 49	200 Hz ~ 10.0 kHz (200 Hz)

• **AGC time constant settings**

Command: 1A 04

Data	AGC time constant (sec.)	
	SSB/CW/RTTY	AM
00	OFF	OFF
01	0.1	0.3
02	0.2	0.5
03	0.3	0.8
04	0.5	1.2
05	0.8	1.6
06	1.2	2.0
07	1.6	2.5
08	2.0	3.0
09	2.5	4.0
10	3.0	5.0
11	4.0	6.0
12	5.0	7.0
13	6.0	8.0

• **RX HPF/LPF setting for each operating mode**

Command: 1A 05 0001, 0004, 0007, 0010, 0015, 0016

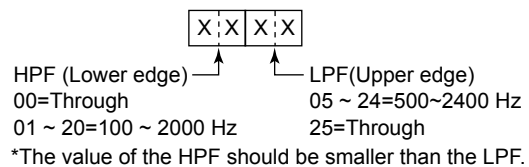

*The value of the HPF should be smaller than the LPF.

• **SSB/SSB-DATA transmission passband width settings**

Command: 1A 05 0019 ~ 0022

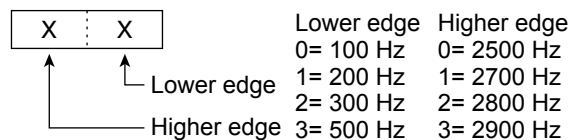

• **Split offset frequency setting**

Command: 1A 05 0046

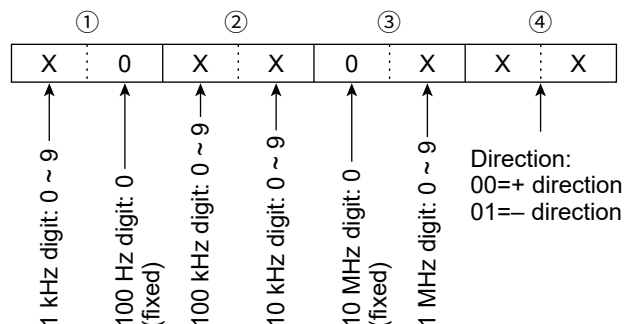

REMOTE CONTROL

Remote control (CI-V) information

◇ Command formats

• UTC Offset setting

Command: 1A 05 0170

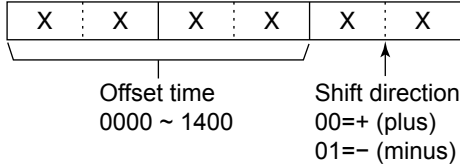

• Remote MIC Key setting

Command: 1A 05 0074 ~ 1A 05 0077

Data	Function
00	No function
01	UP
02	DOWN
03	UP (VFO: kHz)
04	DOWN (VFO: kHz)
05	VOL UP
06	VOL DOWN
07	XFC
08	CALL
09	VFO/MEMO
10	DR
11	FROM/TO (DR)
12	Home CH
13	BAND/GROUP UP
14	BAND/GROUP DOWN
15	SCAN
16	Temporary Skip
17	SPEECH
18	MODE
19	RF Power
20	Voice/Keyer/RTTY Memory 1
21	Voice/Keyer/RTTY Memory 2
22	Voice/Keyer/RTTY Memory 3
23	Voice/Keyer/RTTY Memory 4
24	T-CALL*
25	RX>CS
26	TS
27	MPAD
28	SPLIT
29	A/B
30	TUNER

• Color settings

Command: 1A 05 0180, 0181, 0182, 0240, 0242, 0258, 0262, 0263

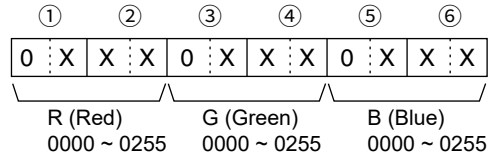

• Bandscope edge frequency settings

Command: 1A 05 0188 ~ 1A 05 0238, 1A 05 0369 ~ 1A 05 0385

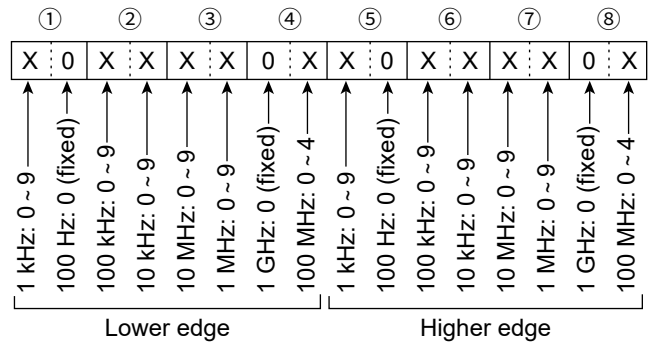

• [VOX/BK-IN] setting

Command: 1A 05 0367

Data	Function
00	TRANSMIT
01	TUNER
02	VOX/BK-IN
03	P.AMP/ATT
04	NOTCH
05	NB
06	NR
07	SPLIT
08	A/B
09	VFO/MEMO
10	CD
11	PRESET
12	Home CH
13	Temporary Skip
14	Voice/Keyer/RTTY Memory 1
15	Voice/Keyer/RTTY Memory 2
16	Voice/Keyer/RTTY Memory 3
17	Voice/Keyer/RTTY Memory 4

* Only for European version.

REMOTE CONTROL

Remote control (CI-V) information

◇ Command formats

• [AUTOTUNE/RX>CS] setting

Command: 1A 05 0368

Data	Function
00	AUTOTUNE/RX>CS
01	CD/RX>CS
02	PRESET/RX>CS
03	Home CH/RX>CS
04	Temporary Skip/RX>CS

• Manually entered position data

Command: 1A 05 0286, 0312, 0326, 23 02

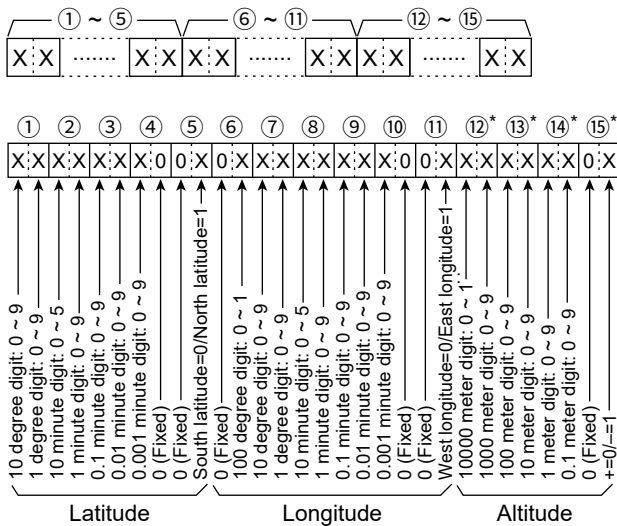

- ① ~ ⑤: Latitude (dd°mm.mmm format)
- ⑥ ~ ⑪: Longitude (ddd°mm.mmm format)
- ⑫ ~ ⑮: Altitude (0.1 meter steps)
- * When reading the contents with no altitude, sends ⑫, ⑬, ⑭, and ⑮ as "FF."
- * When sending the contents with no altitude, set ⑫, ⑬, ⑭, and ⑮ to "FF."

• D-PRS Symbol setting

Command: 1A 05 0291 ~ 1A 05 0294, 1A 05 0310, 0324, 0335

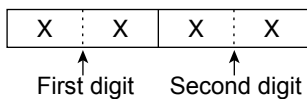

- /, \, 0 to 9, A to Z can be used for the first digit character.
- See "Codes for character entries" for the second digit character. (p. 19)

• Alarm area (Group) setting

Command: 1A 05 0346

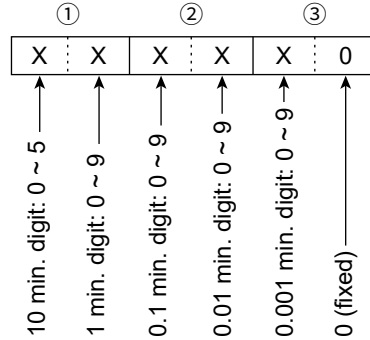

• Data mode with filter width settings

Command: 1A 06

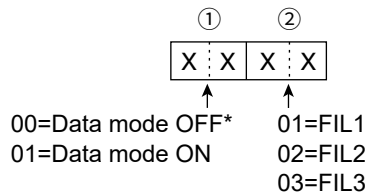

*When 00 is set, also set 00 to ②.

• Repeater tone/tone squelch frequency settings

Command: 1B 00, 1B 01

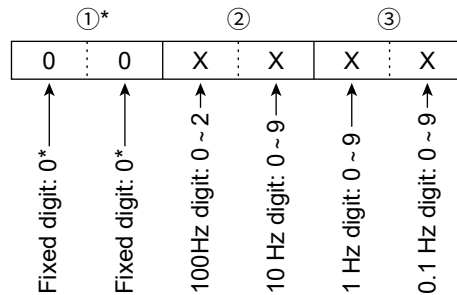

*Not necessary when setting a frequency.

• DTCS code and polarity setting

Command: 1B 02

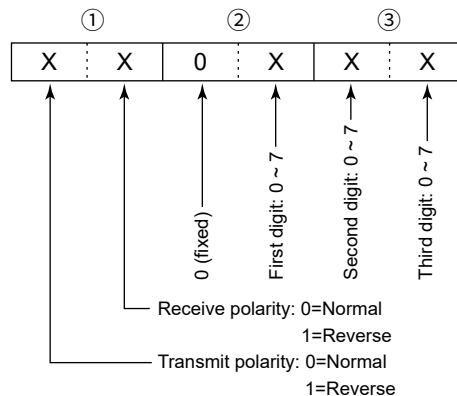

Remote control (CI-V) information

◇ Command formats

• DV Digital code squelch setting

Command: 1B 07

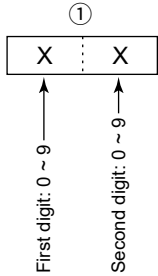

• DV MY call sign setting

Command: 1F 01

Set your own call sign and note of up to 12 characters.

See “Character’s code of the call sign.”

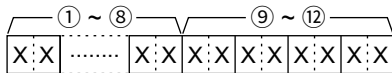

- ① ~ ⑧: Your own call sign setting (8 characters)
- ⑨ ~ ⑫: Note setting (4 characters)

• DV TX call signs setting (24 characters)

Command: 1F 01

Set “UR,” “R1,” and “R2” call signs of 8 characters (fixed).

See “Character’s code of the call sign.”

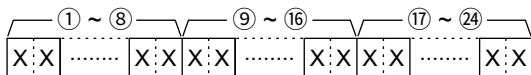

- ① ~ ⑧: UR (Destination) call sign setting (8 characters)
- ⑨ ~ ⑯: R1 (Access/Area repeater) call sign setting (8 characters)
- ⑰ ~ ⑳: R2 (Link/Gateway repeater) call sign setting (8 characters)

Character’s code of the call sign

Character	ASCII code
0 ~ 9	30 ~ 39
A ~ Z	41 ~ 5A
(Space)	20
/	2F

• DV TX message setting

Command: 1F 02

Set the transmit message of up to 20 characters.

See “Codes for character entries.” (p. 19)

“FF” stops sending or reading messages.

• DV RX call sign data

Command: 20 0001, 0002

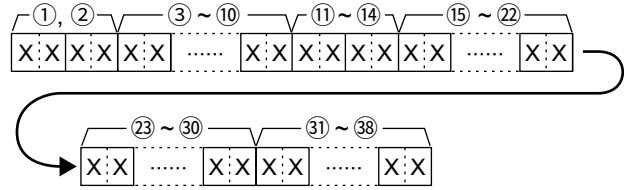

①: Header flag data (First byte)

Data	Description
bit7 (0: Fixed)	—
bit6 (0: Fixed)	—
bit5 (0: Fixed)	—
bit4 0/1	0=Voice, 1=Data
bit3 0/1	0=Direct, 1=Through repeater
bit2 0/1	0=No Break-in, 1=Break-in
bit1 0/1	0=Data, 1=Control
bit0 0/1	0=Normal, 1=EMR

②: Header flag data (Second byte)

Data			Description
bit2	bit1	bit0	
1	1	1	Repeater control
1	1	0	Send auto acknowledge
1	0	1	(Not used)
1	0	0	Request to re-transmit
0	1	1	Send acknowledge
0	1	0	Receive no reply
0	0	1	Repeater disabled
0	0	0	NULL

- ③ ~ ⑩: Call sign of the caller station (8 characters, fixed)
- ⑪ ~ ⑭: Note of the caller station (4 characters, fixed)
- ⑮ ~ ⑳: Call sign of the called station (8 characters, fixed)
- ㉓ ~ ㉟: Call sign of the access/area repeater (R1) (8 characters, fixed)
- ㉫ ~ ㉰: Call sign of the link/gateway repeater (R2) (8 characters, fixed)

See “Codes for character entries.” (p. 19)

①FF: When no call sign is received since the transceiver power was turned ON.

Remote control (CI-V) information

◇ Command formats

• DV RX message

Command: 20 0101, 0102

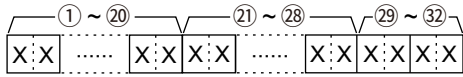

- ① ~ ⑳: Message (20 characters)
 - ㉑ ~ ㉘: Call sign of the caller station (8 characters)
 - ㉙ ~ ㉚: Note of the caller station (4 characters)
- See “Codes for character entries.” (p. 19)
- ①FF: When no call sign is received since the transceiver power was turned ON.

Example: When a Gateway call is received

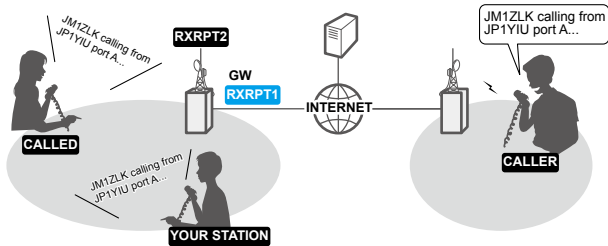

- CALLER: Caller’s call sign
- CALLED: Called station call sign
- RXRPT1: Call sign of the repeater that was accessed by the caller station
 - ① If it was a call through a gateway and the internet, this item displays the gateway call sign of the repeater you received the call from.
- RXRPT2: Call sign of the repeater you received the call from

• DV RX Status setting

Command: 20 0201, 0202

Data	Function	Description
bit7	0 (Fixed)	—
bit6	0/1	Receiving a voice call While receiving a digital voice signal, select “1.” (Regardless of DSQ and CSQ setting)
bit5	0/1	Last call finisher When the last call was finished by you, select “1.”
bit4	0/1	Receiving a signal When the audio tone can be heard, select “1.”
bit3	0/1	Receiving a BK call While receiving a BK call, select “1.”
bit2	0/1	Receiving a EMR call While receiving a EMR call, select “1.”
bit1	0/1	Receiving a signal other than DV When “DV” and “FM” are blinking, select “1.”
bit0	0/1	Packet loss status While displaying packet loss, “1” is returned.

• GPS/D-PRS data

Command: 20 03 0100, 0101, 0102, 0103, 0200, 0201, 0202, 0203

Data number and description

Data number	Description
00	D-PRS — Position
01	D-PRS — Object
02	D-PRS — Item
03	D-PRS — Weather

Position

Command: 20 03 0100, 0200

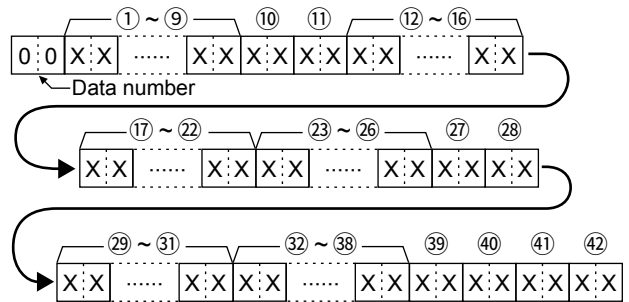

- ① ~ ⑨: Call sign/SSID
(9 ASCII characters (A ~ Z, 0 ~ 9, /, -, space))
- ⑩, ⑪: Symbol (2 ASCII characters (00h ~ EFh))
- ⑫ ~ ⑯: Latitude (dd°mm.mmm format)
- ⑰ ~ ⑳: Longitude (ddd°mm.mmm format)
- ㉓ ~ ㉖: Altitude (0.1 meter steps)
- ㉗, ㉘: Course (1 degree steps)
- ㉙ ~ ㉛: Speed (0.1 km/h steps)
- ㉜ ~ ㉝: Date (UTC: yyymmddHHMMSS)
(y: Year, m: Month, d: Day, H: Hour, M: Minute, S: Second)
- ㉞ ~ ㉟: See the table below.

	⑳ Power	㉑ Height	㉒ Gain	㉓ Directivity
Data	(W)	(m/ft)	(dB)	(deg)
0	0	3/10	0	Omni-direction
1	1	6/20	1	45° NE
2	4	12/40	2	90° E
3	9	24/80	3	135° SE
4	16	49/160	4	180° S
5	25	98/320	5	225° SW
6	36	195/640	6	270° W
7	49	390/1280	7	315° NW
8	64	780/2560	8	360° N
9	81	1561/5120	9	—

- ① The item, that is not contained the received data, is filled with “FF.”
- ① FF: No signal has been received since the power was turned ON.

REMOTE CONTROL

Remote control (CI-V) information

◇ Command formats

- GPS/D-PRS data (Continued)

Object

Command: 20 03 0101, 0201

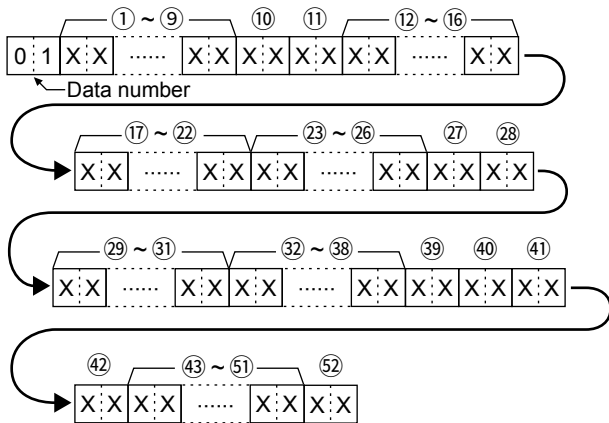

- ① ~ ⑨: Call sign/SSID
(9 ASCII characters (A ~ Z, 0 ~ 9, /, -, space))
- ⑩, ⑪: Symbol (2 ASCII characters (00h ~ EFh))
- ⑫ ~ ⑯: Latitude (dd°mm.mmm format)
- ⑰ ~ ⑳: Longitude (ddd°mm.mmm format)
- ㉓ ~ ㉖: Altitude (0.1 meter steps)
- ㉗, ㉘: Course (1 degree steps)
- ㉙ ~ ㉛: Speed (0.1 km/h steps)
- ㉜ ~ ㉞: Date (UTC: yyyyymmddHHMMSS)
(y: Year, m: Month, d: Day,
H: Hour, M: Minute, S: Second)
- ㉟ ~ ㊲: See the table below.

	③⑨ Power	④⑩ Height	④① Gain	④② Directivity
Data	(W)	(m/ft)	(dB)	(deg)
0	0	3/10	0	Omni-direction
1	1	6/20	1	45° NE
2	4	12/40	2	90° E
3	9	24/80	3	135° SE
4	16	49/160	4	180° S
5	25	98/320	5	225° SW
6	36	195/640	6	270° W
7	49	390/1280	7	315° NW
8	64	780/2560	8	360° N
9	81	1561/5120	9	—

- ④③ ~ ④①: Name
(9 ASCII characters (00h ~ EFh))
- ④②: Type (1= Live, 0= Killed)

- ① The item, that is not contained the received data, is filled with "FF."
- ① FF: No signal has been received since the power was turned ON.

Item

Command: 20 03 0102, 0202

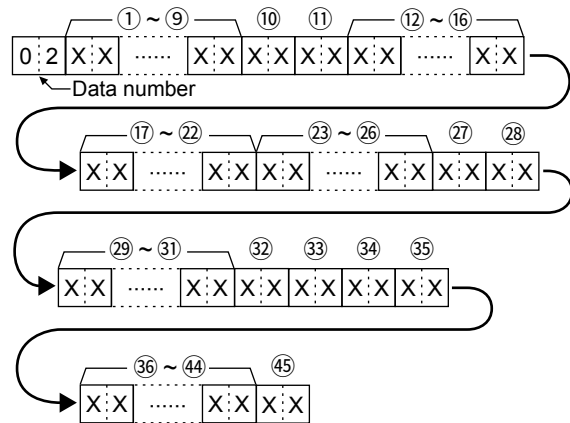

- ① ~ ⑨: Call sign/SSID
(9 ASCII characters (A ~ Z, 0 ~ 9, /, -, space))
- ⑩, ⑪: Symbol (2 ASCII characters (00h ~ EFh))
- ⑫ ~ ⑯: Latitude (dd°mm.mmm format)
- ⑰ ~ ⑳: Longitude (ddd°mm.mmm format)
- ㉓ ~ ㉖: Altitude (0.1 meter steps)
- ㉗, ㉘: Course (1 degree steps)
- ㉙ ~ ㉛: Speed (0.1 km/h steps)
- ㉜ ~ ㉝: See the table below.

	③② Power	③③ Height	③④ Gain	③⑤ Directivity
Data	(W)	(m/ft)	(dB)	(deg)
0	0	3/10	0	Omni-direction
1	1	6/20	1	45° NE
2	4	12/40	2	90° E
3	9	24/80	3	135° SE
4	16	49/160	4	180° S
5	25	98/320	5	225° SW
6	36	195/640	6	270° W
7	49	390/1280	7	315° NW
8	64	780/2560	8	360° N
9	81	1561/5120	9	—

- ③⑥ ~ ④④: Name
(9 ASCII characters (00h ~ EFh))
- ④⑤: Type (1= Live, 0= Killed)

- ① The item, that is not contained the received data, is filled with "FF."
- ① FF: No signal has been received since the power was turned ON.

Remote control (CI-V) information

◇ Command formats

• GPS/D-PRS data (Continued)

Weather

Command: 20 03 0103, 0203

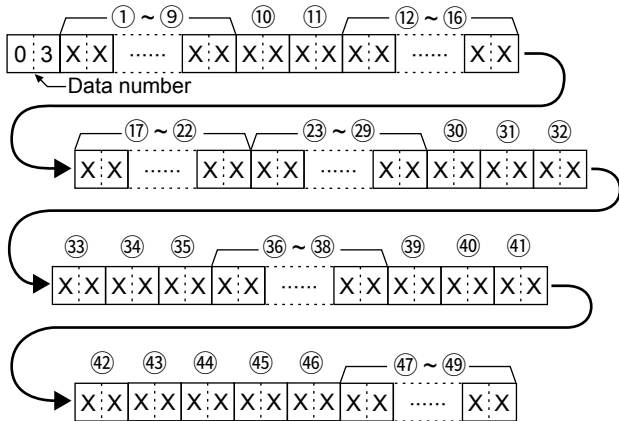

- ① ~ ⑨: Call sign/SSID
(9 ASCII characters (A ~ Z, 0 ~ 9, /, -, space))
- ⑩, ⑪: Symbol (2 ASCII characters (00h ~ EFh))
- ⑫ ~ ⑯: Latitude (dd°mm.mmm format)
- ⑰ ~ ⑳: Longitude (ddd°mm.mmm format)
- ㉓ ~ ㉙: Date (UTC: yyyyymmddHHMMSS)
(y: Year, m: Month, d: Day, H: Hour, M: Minute, S: Second)
- ⑳, ㉑: Wind direction (1 degree steps)
- ㉒, ㉓: Wind speed (0.1 m/s steps)
- ㉔, ㉕: Gust speed (0.1 m/s steps)
- ㉖ ~ ㉗: Temperature (0.1°C steps)
- ㉘: Temperature (0= + degree, 1= - degree)
- ㉙, ㉚: Rainfall (0.1 mm steps)
- ㉛, ㉜: Rainfall (24 hours) (0.1 mm steps)
- ㉝, ㉞: Rainfall (Midnight) (0.1 mm steps)
- ㉟, ㊱: Humidity (1% steps)
- ㊲ ~ ㊴: Barometric pressure (0.1 hPa steps)

- ① The item, that is not contained the received data, is filled with "FF."
- ① FF: No signal has been received since the power was turned ON.

• **GPS/D-PRS message**

Command: 20 0401, 0402

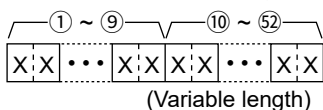

- ① ~ ⑨: Call sign/SSID
(9 ASCII characters (A ~ Z, 0 ~ 9, /, -, space))
- ⑩ ~ ⑵②: Message
(Up to 43 ASCII characters (00h ~ EFh))
- ① FF: No signal has been received since the power was turned ON.

• **RIT frequency settings**

Command: 21 00

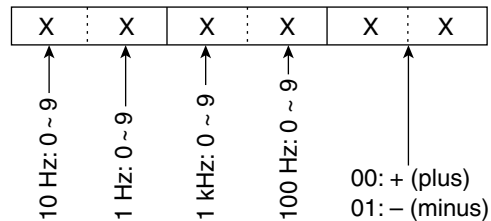

• **DV TX data**

Command: 22 00

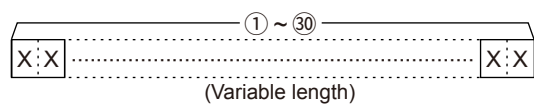

- ① ~ ⑳⑩: TX data (Up to 30 Byte)
- ① "FA" to "FF" are entered after converted to "FF 0A" to "FF 0F" automatically. Up to 60 Byte data can be entered in this case.

• **DV RX data (transceive)**

Command: 22 0101

- ① ~ ⑳⑩: RX data (Up to 30 Byte)
- ① "FA" to "FF" are entered after converted to "FF 0A" to "FF 0F" automatically. Up to 60 Byte data can be entered in this case.

• **MY position data**

Command: 23 00

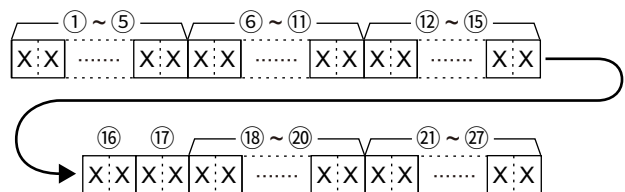

- ① ~ ⑵⑤: Latitude (dd°mm.mmm format)
- ⑶ ~ ⑾①: Longitude (ddd°mm.mmm format)
- ⑿ ~ ⑽⑤: Altitude (0.1 meter steps)
- ⑽⑥, ⑽⑦: Course (1 degree steps)
- ⑽⑸ ~ ⑽⑹①: Speed (0.1 km/h steps)
- ⑽⑹② ~ ⑽⑹⑦: Date (UTC: yyyyymmddHHMMSS)
(y: Year, m: Month, d: Day, H: Hour, M: Minute, S: Second)

Remote control (CI-V) information

◇ Command formats

• Selected or unselected VFO frequency settings

Command: 25

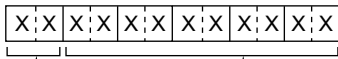

00=Selected VFO
01=Unselected VFO
Operating frequency
See "Operating frequency." (p. 17)

① When using the DR function, the transceiver returns "FA" (NG) because these cannot be set to 01.

- When VFO A is selected
00=frequency of VFO A changes
01=frequency of VFO B changes
- When VFO B is selected
00=frequency of VFO B changes
01=frequency of VFO A changes

• Selected or unselected VFO's operating mode and filter settings

Command: 26

Both data and filter settings can be skipped. In that case, "DATA OFF" and the default filter setting of the operating mode is automatically selected.

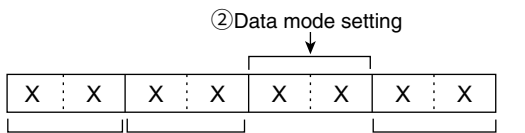

00=Selected VFO
01=Unselected VFO

① When using the DR function, the transceiver returns "FA" (NG) because these cannot be set to 01.

- When VFO A is selected
00 = operating mode of VFO A changes
01 = operating mode of VFO B changes
- When VFO B is selected
00 = operating mode of VFO B changes
01 = operating mode of VFO A changes

① Operating mode setting		② Data mode setting		③ Filter setting	
00:LSB	05:FM	00: Data mode OFF	01:FIL1		
01:USB	06:WFM	01: Data mode ON	02:FIL2		
02:AM	07:CW-R	—	03:FIL3		
03:CW	08:RTTY-R	—	—		
04:RTTY	17:DV	—	—		

• Scope waveform data

Command: 27 00

Outputs the waveform data to the controller.

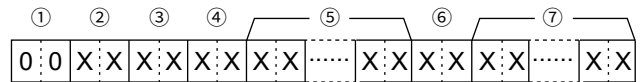

- ①: 00 (Fixed)
- ②: Order of division data (Current): 01~11
- ③: Division number (Maximum): 01(WLAN), 11(USB)
 - ① When data is sent to the controller using the WLAN function, all data is sent together. However, when the data is sent through the [microUSB] port, the data is divided by 11 and sent in sequential order.
 - ① The 1st data sends only the wave information (① ~ ⑥) without the waveform data (⑦). The 2nd or later data sends the minimum wave information (① ~ ③) with waveform data (⑦).
- ④: Spectrum scope mode data:
 - 00 = Center mode scope
 - 01 = Fixed mode scope
 - 02 = SCROLL-C mode scope
 - 03 = SCROLL-F mode scope

- ⑤: Waveform information:

The waveform information differs, depending on the Spectrum scope mode.

 - In the Center mode:

Center frequency and span are sent.
See page 17 for Operating frequency data, and the Scope span settings (② ~ ⑥) on page 28.
 - In the Fixed, SCROLL-C, and SCROLL-F modes:

Lower edge and higher edge frequencies are sent.

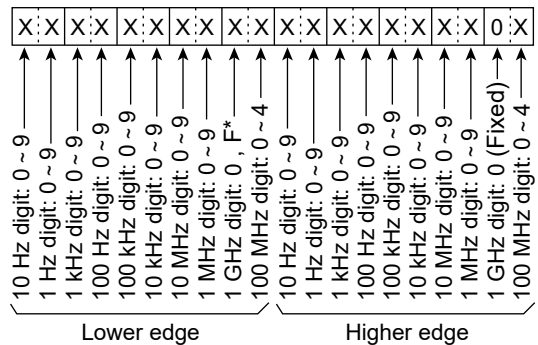

* "F" means that the Lower edge frequency is a negative value.

(Continued on the next page.)

Remote control (CI-V) information

◆ Command formats

- ⑥: Out of range information:
 - 00 = In range
 - 01 = Out of range
- ① If the scope data is out of range, the waveform data (⑦) is omitted.
- ⑦: Waveform data:

The transceiver outputs the drawn waveform data. The data range or data length of the waveform data is judged by the controller. (The data range is basically the same as the display size of the scope on the controller.)

 - Data range: 0 ~ 160
 - Data length: 475

• Scope Fixed edge frequency settings

Command: 27 1E

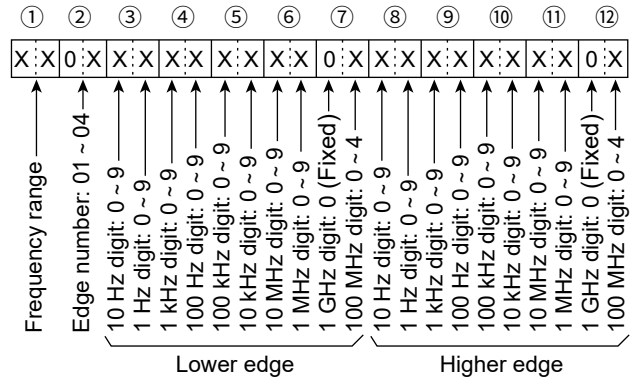

① Entry of less than 1 kHz digits are ignored.

① Selectable Frequency ranges:

Data	Frequency range (Hz)
01	0.03 ~ 1.60
02	1.60 ~ 2.00
03	2.00 ~ 6.00
04	6.00 ~ 8.00
05	8.00 ~ 11.00
06	11.00 ~ 15.00
07	15.00 ~ 20.00
08	20.00 ~ 22.00
09	22.00 ~ 26.00
10	26.00 ~ 30.00
11	30.00 ~ 45.00
12	45.00 ~ 60.00
13	60.00 ~ 74.80
14	74.80 ~ 108.00
15	108.00 ~ 137.00
16	137.00 ~ 200.00
17	400.00 ~ 470.00

② Selectable Edge number: 01=1, 02=2, 03=3, 04=4

• Scope span settings

(in the Center mode and SCROLL-C mode Scope)

Command: 27 15

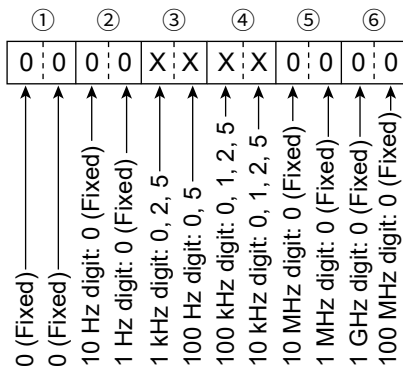

Span (kHz)	
2500	2.5
5000	5
10000	10
25000	25
50000	50
100000	100
250000	250
500000	500

• Scope Reference level settings

Command: 27 19

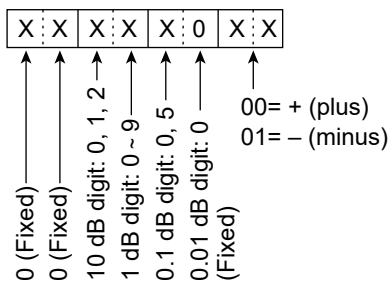

Adjustable range: -20.0 dB ~ +20.0 dB
in 0.5 dB steps.

Count on us!